

HI83300

Multiparameter
Photometer



INSTRUCTION MANUAL

**Dear
Customer,**

Thank you for choosing a Hanna Instruments product.

Please read this instruction manual carefully before using the instrument.

This manual will provide you with the necessary information for correct use of the instrument, as well as a precise idea of its versatility.

If you need additional technical information, do not hesitate to e-mail us at tech@hannainst.com or view our worldwide contact list at www.hannainst.com.

All rights are reserved. Reproduction in whole or in part is prohibited without the written consent of the copyright owner, Hanna Instruments Inc., Woonsocket, Rhode Island, 02895, USA.

| | |
|---|----|
| 1. PRELIMINARY EXAMINATION..... | 6 |
| 2. SAFETY MEASURES..... | 6 |
| 3. SPECIFICATIONS..... | 7 |
| 4. DESCRIPTION..... | 8 |
| 4.1. GENERAL DESCRIPTION..... | 8 |
| 4.2. PRECISION AND ACCURACY..... | 8 |
| 4.3. FUNCTIONAL DESCRIPTION..... | 9 |
| 4.4. PRINCIPLE OF OPERATION..... | 10 |
| 4.5. OPTICAL SYSTEM..... | 11 |
| 5. GENERAL OPERATIONS..... | 12 |
| 5.1. POWER CONNECTION AND BATTERY MANAGEMENT..... | 12 |
| 5.2. GENERAL SETUP..... | 12 |
| 5.3. USING HANNA DIGITAL ELECTRODES..... | 15 |
| 5.4. MODE SELECTION..... | 15 |
| 5.5. LOGGING DATA..... | 16 |
| 5.6. ADDING SAMPLE / USER NAMES TO LOG DATA..... | 16 |
| 5.7. DATA MANAGEMENT..... | 17 |
| 5.8. CONTEXTUAL HELP..... | 18 |
| 6. PHOTOMETER MODE..... | 18 |
| 6.1. METHOD SELECTION..... | 18 |
| 6.2. COLLECTING AND MEASURING SAMPLES AND REAGENTS..... | 19 |
| 6.2.1. PROPER USE OF SYRINGE..... | 19 |
| 6.2.2. PROPER USE OF DROPPER..... | 19 |
| 6.2.3. PROPER USE OF POWDER PACKET..... | 19 |
| 6.3. CUVETTE PREPARATION..... | 20 |
| 6.4. TIMERS AND MEASUREMENT FUNCTIONS..... | 21 |
| 6.5. CHEMICAL FORMULA / UNIT CONVERSIONS..... | 22 |
| 6.6. METER VALIDATION / CAL CHECK..... | 22 |
| 6.7. ABSORBANCE MEASUREMENTS..... | 23 |
| 7. PROBE MODE..... | 24 |
| 7.1. pH CALIBRATION..... | 24 |
| 7.2. pH CALIBRATION MESSAGES..... | 26 |
| 7.3. pH MEASUREMENT..... | 26 |
| 7.4. pH MEASUREMENT MESSAGES / WARNINGS..... | 28 |
| 7.5. pH GLP..... | 29 |
| 7.6. pH ELECTRODE CONDITIONING AND MAINTENANCE..... | 30 |

| | |
|---|-----|
| 8. METHOD PROCEDURES..... | 32 |
| 8.1. ALKALINITY..... | 32 |
| 8.2. ALKALINITY, MARINE..... | 34 |
| 8.3. ALUMINUM..... | 36 |
| 8.4. AMMONIA LOW RANGE..... | 39 |
| 8.5. AMMONIA MEDIUM RANGE..... | 42 |
| 8.6. AMMONIA HIGH RANGE..... | 45 |
| 8.7. BROMINE..... | 48 |
| 8.8. CALCIUM..... | 50 |
| 8.9. CALCIUM, MARINE..... | 53 |
| 8.10. CHLORIDE..... | 55 |
| 8.11. CHLORINE DIOXIDE..... | 59 |
| 8.12. CHLORINE, FREE..... | 62 |
| 8.13. CHLORINE, FREE ULTRA LOW RANGE..... | 65 |
| 8.14. CHLORINE, TOTAL..... | 67 |
| 8.15. CHLORINE, TOTAL ULTRA LOW RANGE..... | 70 |
| 8.16. CHLORINE, TOTAL ULTRA HIGH RANGE..... | 72 |
| 8.17. CHROMIUM (VI) LOW RANGE..... | 74 |
| 8.18. CHROMIUM (VI) HIGH RANGE..... | 76 |
| 8.19. COLOR OF WATER..... | 78 |
| 8.20. COPPER LOW RANGE..... | 80 |
| 8.21. COPPER HIGH RAGE..... | 82 |
| 8.22. CYANURIC ACID..... | 84 |
| 8.23. FLUORIDE LOW RANGE..... | 86 |
| 8.24. FLUORIDE HIGH RANGE..... | 88 |
| 8.25. HARDNESS, CALCIUM..... | 91 |
| 8.26. HARDNESS, MAGNESIUM..... | 94 |
| 8.27. HARDNESS, TOTAL LOW RANGE..... | 97 |
| 8.28. HARDNESS, TOTAL MEDIUM RANGE..... | 100 |
| 8.29. HARDNESS, TOTAL HIGH RANGE..... | 103 |
| 8.30. HYDRAZINE..... | 106 |
| 8.31. IODINE..... | 108 |
| 8.32. IRON LOW RANGE..... | 110 |
| 8.33. IRON HIGH RANGE..... | 113 |
| 8.34. MAGNESIUM..... | 115 |
| 8.35. MANGANESE LOW RANGE..... | 117 |

| | |
|--|-----|
| 8.36. MANGANESE HIGH RANGE..... | 120 |
| 8.37. MOLYBDENUM..... | 123 |
| 8.38. NICKEL LOW RANGE..... | 126 |
| 8.39. NICKEL HIGH RANGE..... | 129 |
| 8.40. NITRATE..... | 131 |
| 8.41. NITRITE, MARINE ULTRA LOW RANGE..... | 134 |
| 8.42. NITRITE LOW RANGE..... | 136 |
| 8.43. NITRITE HIGH RANGE..... | 139 |
| 8.44. OXYGEN, DISSOLVED..... | 141 |
| 8.45. OXYGEN SCAVENGERS (CARBOHYDRAZIDE)..... | 144 |
| 8.46. OXYGEN SCAVENGERS (DIETHYLHYDROXYLAMINE) (DEHA)..... | 147 |
| 8.47. OXYGEN SCAVENGERS (HYDROQUINONE)..... | 150 |
| 8.48. OXYGEN SCAVENGERS (ISO-ASCORBIC ACID)..... | 153 |
| 8.49. OZONE..... | 156 |
| 8.50. pH..... | 160 |
| 8.51. PHOSPHATE, MARINE ULTRA LOW RANGE..... | 162 |
| 8.52. PHOSPHATE LOW RANGE..... | 164 |
| 8.53. PHOSPHATE HIGH RANGE..... | 166 |
| 8.54. POTASSIUM..... | 169 |
| 8.55. SILICA LOW RANGE..... | 172 |
| 8.56. SILICA HIGH RANGE..... | 175 |
| 8.57. SILVER..... | 178 |
| 8.58. SULFATE..... | 182 |
| 8.59. SURFACTANTS, ANIONIC..... | 184 |
| 8.60. ZINC..... | 188 |
| 9. ERROR DESCRIPTIONS..... | 191 |
| 10. STANDARD METHODS..... | 192 |
| 11. ACCESSORIES..... | 195 |
| 11.1. REAGENT SETS..... | 195 |
| 11.2. pH ELECTRODES..... | 198 |
| 11.3. pH SOLUTIONS..... | 199 |
| 11.4. OTHER ACCESSORIES..... | 200 |
| 12. ABBREVIATIONS..... | 201 |
| RECOMMENDATIONS FOR USERS..... | 202 |
| WARRANTY..... | 203 |

1. PRELIMINARY EXAMINATION

Remove the instrument and accessories from the packaging and examine it carefully to make sure that no damage has occurred during shipping. Notify your nearest Hanna Customer Service Center if damage is observed.

Each HI83300 is supplied with:

- Sample Cuvette and Cap (4 pcs.)
- Cloth for Wiping Cuvettes
- Scissors
- USB Cable
- 5 Vdc Power Adapter
- Instruction Manual
- DO bottle (glass stopper bottle)
- Quality Certificate

Note: Save all packing material until you are sure that the instrument works correctly. Any damaged or defective item must be returned in its original packing material with the supplied accessories.

2. SAFETY MEASURES



- The chemicals contained in the reagent kits may be hazardous if improperly handled.
- Read the Safety Data Sheets (SDS) before performing tests.
- Safety equipment: Wear suitable eye protection and clothing when required, and follow instructions carefully.
- Reagent spills: If a reagent spill occurs, wipe up immediately and rinse with plenty of water. If reagent contacts skin, rinse the affected area thoroughly with water. Avoid breathing released vapors.
- Waste disposal: for proper disposal of reagent kits and reacted samples, contact a licensed waste disposal provider.

3. SPECIFICATIONS

| | | |
|---------------------------|---|--|
| Measurement Channels | 5 x optical channels; 1 x digital electrode channel (pH measurement) | |
| Absorbance | Range | 0.000 to 4.000 Abs |
| | Resolution | 0.001 Abs |
| | Accuracy | ± 0.003 Abs (at 1.000 Abs) |
| | Light Source | light emitting diode |
| | Bandpass Filter Bandwidth | 8 nm |
| | Bandpass Filter Wavelength Accuracy | ± 1.0 nm |
| | Light Detector | silicon photocell |
| | Cuvette Types | round, 24.6 mm diameter |
| | Number of Methods | 65 |
| pH | Range | -2.00 to 16.00 pH (± 1000.0 mV)* |
| | Resolution | 0.01 pH (0.1 mV) |
| | Accuracy | ± 0.01 pH (± 0.2 mV) (@ 25 °C / 77 °F) |
| | Temperature Compensation | ATC (-5.0 to 100.0 °C; 23.0 to 212.0 °F)* |
| | Calibration | 2 points, eligible from 5 available buffers (4.01, 6.86, 7.01, 9.18, 10.01 pH) |
| Temperature | Electrode | Intelligent pH / temperature electrode |
| | Range | -20.0 to 120.0°C (-4.0 to 248.0 °F) |
| | Resolution | 0.1 °C (0.1 °F) |
| | Accuracy | ± 0.5 °C (± 0.9 °F) (@ 25 °C / 77 °F) |
| Additional Specifications | Logging | 1000 readings (mixed photometer and electrode) |
| | Display | 128 x 64 pixel B/W LCD with backlight |
| | USB-A (Host) Functions | mass-storage host |
| | USB-B (Device) Functions | power input, mass-storage device |
| | Battery Life | > 500 photometer measurements, or 50 hours of continuous pH measurement |
| | Power Supply | 5 Vdc USB 2.0 power adapter/type micro-B connector 3.7 Vdc Li-polymer rechargeable battery, non-serviceable |
| | Environment | 0 to 50 °C (32 to 122 °F); 0 to 95% RH, non-serviceable |
| | Dimensions | 206 x 177 x 97 mm (8.1 x 7.0 x 3.8") |
| | Weight | 1.0 kg (2.2 lbs.) |

*Limits will be reduced to actual probe/sensor limits.

4. DESCRIPTION

4.1. GENERAL DESCRIPTION

HI83300 multiparameter photometer is compact and versatile meter with two measurement modes: Absorbance and pH/ mV. Absorbance mode include CAL Check feature and 65 different methods that cover a wide variety of applications, making it ideal for both benchtop and portable operation.

- Digital electrode input for pH measurements
- Certified CAL Check cuvettes to confirm meter functionality
- Dual purpose micro-USB flash drive
- Li-polymer rechargeable battery
- Auto-off
- Absorbance mode
- User and sample name entry
- GLP features

4.2. PRECISION AND ACCURACY

Precision is how closely repeated measurements are to one another. Precision is usually expressed as standard deviation (SD).

Accuracy is defined as the closeness of a test result to the true value.

Although good precision suggests good accuracy, precise results can be inaccurate. The figure explains these definitions.

For each method, the accuracy is expressed in the related measurement section.

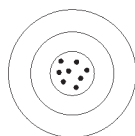

Precise, accurate

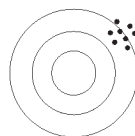

Precise, not accurate

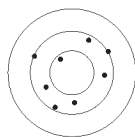

Not precise, accurate

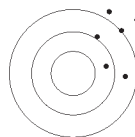

Not precise, not accurate



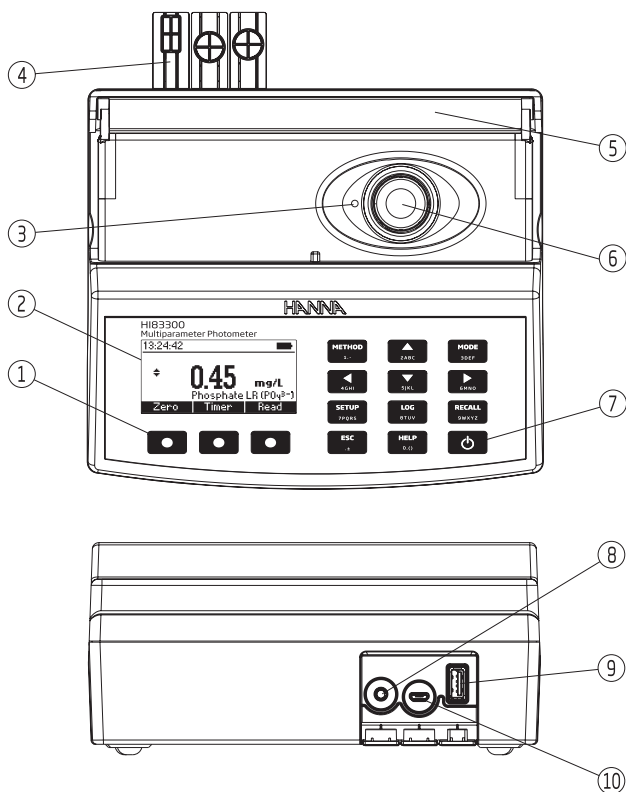









4.3. FUNCTIONAL DESCRIPTION



- 1) Splash-proof keypad
- 2) Liquid Crystal Display (LCD)
- 3) Indexing mark
- 4) Protective port covers
- 5) Light-blocking cover panel
- 6) Cuvette holder
- 7) ON/OFF power button
- 8) 3.5 mm TRRS (jack) input for digital electrodes
- 9) Standard USB host connector for data transfer to a USB flash drive
- 10) Micro-USB device connector for power or PC interface

Keypad Description

The keypad contains 12 direct keys and 3 functional keys with the following functions:

-  Press the functional keys to perform the function displayed above them on the LCD.
-  Press to access the list of photometer methods.
-  Press to move up in a menu or a help screen, to increment a set value, or to access second level functions.
-  Press to toggle between photometer and pH (electrode) mode.
-  Press to move left in a menu or to decrement a set value.
-  Press to move down in a menu or a help screen, to decrement a set value, or to access second level functions.
-  Press to move right in a menu or to increment a set value.
-  Press to access the setup screen.
-  Press to log the current reading.
-  Press to review saved logs.
-  Press to exit the current screen.
-  Press to display the help screen.
-  ON/OFF power button.

4.4. PRINCIPLE OF OPERATION

Absorption of light is a typical phenomenon of interaction between electromagnetic radiation and matter. When a light beam crosses a substance, some of the radiation may be absorbed by atoms, molecules or crystal lattices.

If pure absorption occurs, the fraction of light absorbed depends both on the optical path length through the matter and on the physical-chemical characteristics of the substance according to the Lambert-Beer Law:

$$-\log I/I_0 = \epsilon_\lambda c d$$

or

$$A = \epsilon_\lambda c d$$

| | | |
|----------------------|---|--|
| I_o | = | intensity of incident light beam |
| I | = | intensity of light beam after absorption |
| ϵ_{λ} | = | molar extinction coefficient at wavelength λ |
| c | = | molar concentration of the substance |
| d | = | optical path through the substance |

Therefore, the concentration "c" can be calculated from the absorbance of the substance as the other factors are constant.

Photometric chemical analysis is based on specific chemical reactions between a sample and reagent to produce a light-absorbing compound.

4.5. OPTICAL SYSTEM

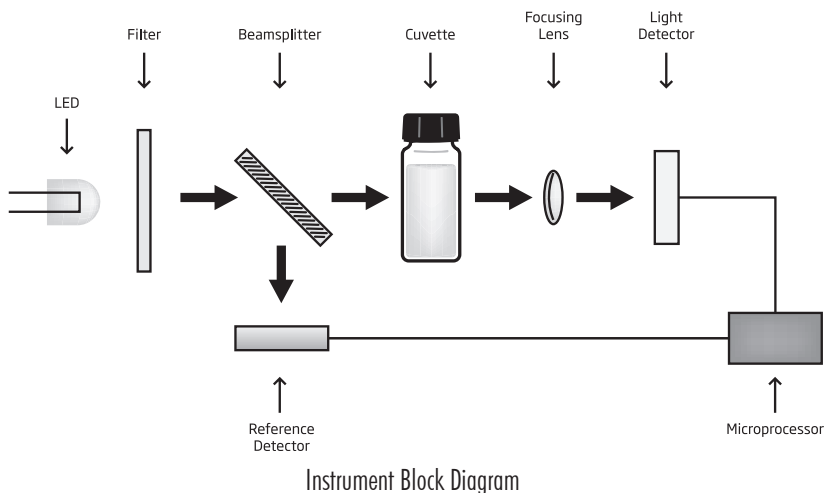

The internal reference system (reference detector) of the [HI83300](#) photometer compensates for any drifts due to power fluctuations or ambient temperature changes, providing a stable source of light for your blank (zero) measurement and sample measurement.

LED light sources offer superior performance compared to tungsten lamps. LEDs have a much higher luminous efficiency, providing more light while using less power. They also produce little heat, which could otherwise affect electronic stability. LEDs are available in a wide array of wavelengths, whereas tungsten lamps have poor blue/violet light output.

Improved optical filters ensure greater wavelength accuracy and allow a brighter, stronger signal to be received. The end result is higher measurement stability and less wavelength error.

A focusing lens collects all of the light that exits the cuvette, eliminating errors from cuvette imperfections and scratches, eliminating the need to index the cuvette.

5. GENERAL OPERATIONS

5.1. POWER CONNECTION AND BATTERY MANAGEMENT

The meter can be powered from an AC/DC adapter (included) or from the built-in rechargeable battery. The meter will perform an auto-diagnostic test when it is first powered on. During this test, the HANNA® logo will appear on the LCD. After 5 seconds, if the test was successful, the last method used will appear on the display. The battery icon on the LCD will indicate the battery status:

- battery is charging from external adapter

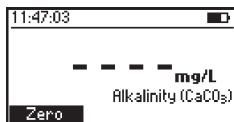

- battery fully charged (meter connected to AC/DC adapter)

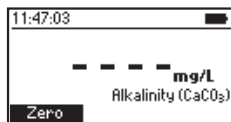

- battery capacity (no external adapter)

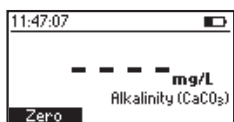

- battery near 0% (no external adapter)

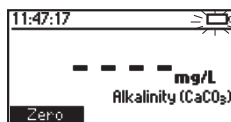

- battery at 0% (no external adapter)

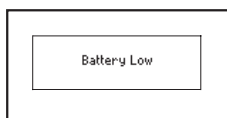

To conserve battery, the meter will turn off automatically after 15 minutes of inactivity (30 minutes before a READ measurement). If a photometer measurement is on the screen, an auto-log is created before shutdown.

5.2. GENERAL SETUP

Press **SETUP** key to enter in **Setup** menu, highlight desired option using  and press **Select**.



CAL Check (Photometer Only)

Press **Select** to enter the CAL Check screen. The date, time and values for the last CAL Check are displayed on the screen.

To start a new CAL Check press **Check** key and follow the prompts on the screen.

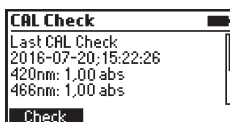
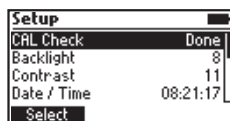

Temperature Unit (pH Only)

Option: °C or °F

Press the functional key to select the desired temperature unit.

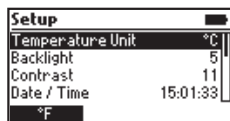

Backlight

Values: 0 to 8

Press the **Modify** key to access the backlight intensity.

Use the functional keys or the ◀ ▶ keys to increase or decrease the value.

Press the **Accept** key to confirm or **ESC** to return to the **Setup** menu without saving the new value.

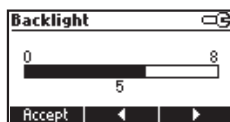
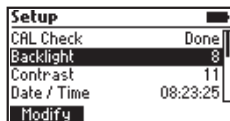

Contrast

Values: 0 to 20

Press the **Modify** key to change the display's contrast.

Use the functional keys or the ◀ ▶ keys to increase or decrease the value.

Press the **Accept** key to confirm the value or **ESC** to return to the **Setup** menu without saving the new value.

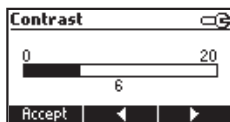
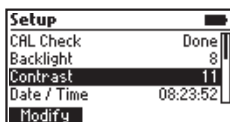

Date / Time

Press the **Modify** key to change the date/time.

Press the functional keys or the ◀ ▶ keys to highlight the value to be modified (year, month, day, hour, minute or second).

Use the ▲ ▼ keys to change the value.

Press the **Accept** key to confirm or **ESC** to return to the **Setup** menu without saving the new date or time.

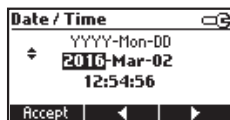

Time Format

Option: AM/PM or 24-hour

Press the functional key to select the desired time format.

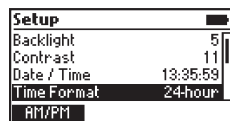

Date Format

Press the **Modify** key to change the Date Format.

Use the **▲ ▼** keys to select the desired format.

Press the **Select** key to confirm or **ESC** to return to the **Setup** menu without saving the new format.

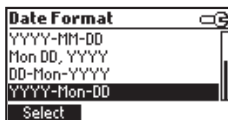
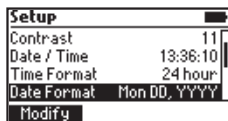

Decimal Separator

Option: Comma (,) or Period (.)

Press the functional key to select the desired decimal separator.

The decimal separator is used on the measurement screen and CSV files.

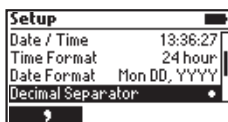

Language

Press the **Modify** key to change the Language. Use the **▲ ▼** keys to select the desired language.

Press **Select** to choose one of the 7 languages installed.

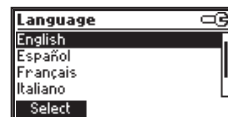
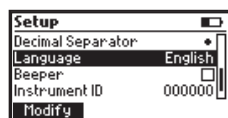

Beeper

Option: Enable or Disable

When enabled, a short beep is heard every time a key is pressed.

A long beep alert sounds when the pressed key is not active or an error is detected. Press the functional key to enable/disable the beeper.

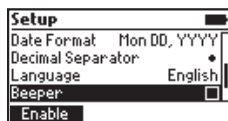

Instrument ID

Option: 0 to 999999

This option is used to set the instrument's ID (identification number). Press the **Modify** key to access the instrument ID screen. Use the functional keys or the **◀ ▶** keys to highlight the digit to be modified. Press the **▲ ▼** keys in order to set the desired value. Press the **Accept** key to confirm the value or **ESC** to return to the **Setup** menu without saving the new value.

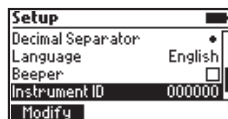

Meter Information

Press the **Select** key to view the model, serial number, firmware version and selected language. Press **ESC** to return to the **Setup** menu.

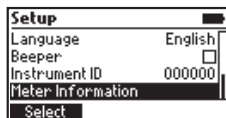

Probe Information (pH mode only)

Press the **Select** key to view model number, serial number and firmware version for the connected probe. Press **ESC** to return to the **Setup** menu.

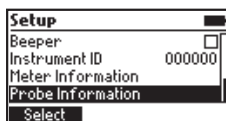

5.3. USING HANNA DIGITAL ELECTRODES

The **HI83300** can be used to perform direct pH measurements by connecting a HANNA® digital pH electrode with a 3.5 mm TRRS connector. To begin taking probe measurements, connect the electrode to the 3.5 mm port marked with “EXT PROBE” located at the rear of the meter. If the meter is in “Photometer Mode”, set the meter to “Probe Mode” by pressing the **MODE** key.

5.4. MODE SELECTION

The **HI83300** has two operational modes: Photometer Mode and Probe Mode.

Photometer Mode enables on-demand measurement of a cuvette using the integrated optical system. Photometric-related functions, such as Method selection, Zero, Read, and Timers are available in this mode.

Probe Mode enables continuous measurement using a Hanna Digital Electrode connected to the 3.5 mm port. Probe-related functions, such as calibration and GLP, are available in this mode. To switch between Photometer Mode and Probe Mode, use the **MODE** button.

Note: The active mode cannot be switched while in menus, such as Setup, Recall, Method, etc.

5.5. LOGGING DATA

The instrument features a data log function to help you keep track of all your analysis. The data log can hold 1000 individual measurements. Storing, viewing and deleting the data is possible using the **LOG** and **RECALL** keys.

Storing data: You can store only a valid measurement. Press **LOG** and the last valid measurement will be stored with date and time stamp.

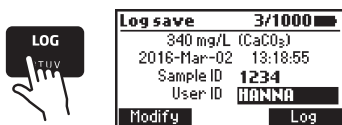

5.6. ADDING SAMPLE / USER NAMES TO LOG DATA

A sample ID and user ID can be added to the saved log. Use the ▲ ▼ keys to highlight the Sample ID or User ID then press **Modify**.

Text Entry

Sample ID and User ID are entered using the alphanumeric multi-tapping keypad.

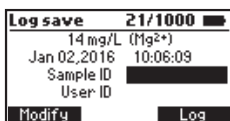

Enter one character at a time by pressing the key with the assigned character repeatedly until the desired character is highlighted. For reference, a list of the characters available for the current key will be shown under the text box.

The character will be entered after a two-second delay or after another key is pressed.

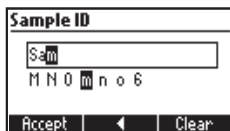

Once all characters have been entered, press **Accept** to use the displayed text.

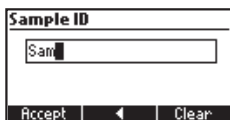

The following functions are available during **Text Entry**:

- **Accept:** Press to accept the current displayed text.
- **Arrow:** Press to delete the last character.
- **Clear:** Press to delete all characters.

ESC

Press to discard all changes and return to the previous screen.

5.7. DATA MANAGEMENT

Viewing and deleting: You can view, export and delete the data by pressing the **RECALL** key. Use the **▲▼** keys to scroll through the saved logs. Press **Info** to view additional information about the selected log.

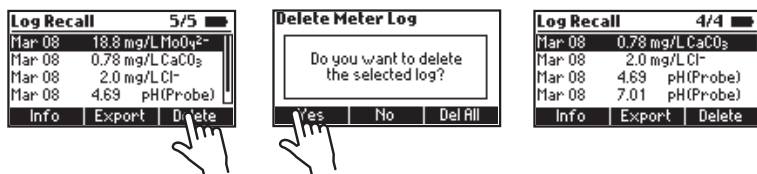

Data Export:

Log data can be exported to a USB flash drive or to a PC. To access Data Export functions, press **Recall** then **Export**.

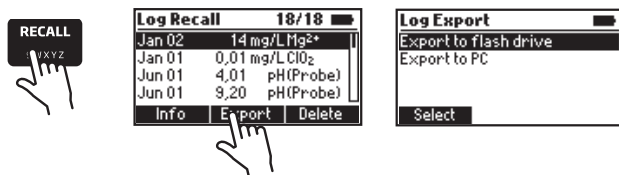

Use the **▲▼** keys to select the desired export location.

For export to USB Flash Drive, insert the USB Flash Drive into the dedicated port at the back of the meter labeled **HOST USB**, then follow the on-screen prompts.

For export to PC, connect the meter to a PC using the supplied micro-USB cable. Insert the cable into the port at the back of the meter labeled **PC PWR**. Follow the on-screen prompts. When the meter says **PC connected**, use a file manager (such as Windows Explorer or Mac Finder) to move the file from the meter to the PC. The meter will appear as a removable disk.

Log data is exported as a single file containing all logged photometer and probe data. The file name is: "HI83300.csv". The CSV file (Comma-Separated Values) may be opened with a text editor or spreadsheet application.

5.8. CONTEXTUAL HELP

HI83300 offers an interactive contextual help mode that assists the user at any time.

To access the help screen press **HELP**.

The instrument will display additional information related to the current screen. To read all the available information, scroll the text using the ▲ ▼ keys.

To exit help mode press **ESC** key and the meter will return to the previous screen.

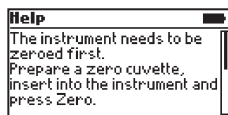

6. PHOTOMETER MODE

6.1. METHOD SELECTION

In order to select the desired method press the **METHOD** key and a screen with the available methods will appear.

Press the ▲ ▼ keys to highlight the desired method. Press **Select**.

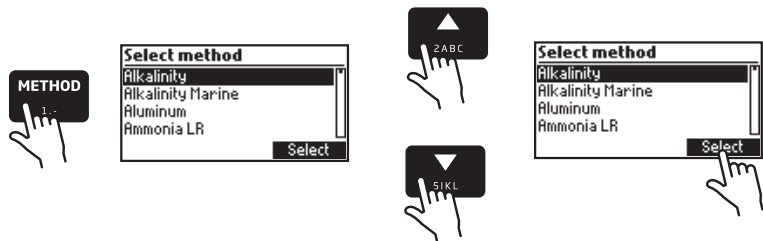

After the desired method is selected, follow the procedure described in the related section. Before performing a method read all the instructions carefully.

6.2. COLLECTING AND MEASURING SAMPLES AND REAGENTS

6.2.1. PROPER USE OF SYRINGE

- Push the plunger completely into the syringe and insert the tip into the solution.
- Pull the plunger up until the lower edge of the seal is exactly on the mark for the desired volume.
- Take out the syringe and clean the outside of the syringe tip, be sure that no drops are hanging on the tip of the syringe. Then, keeping the syringe in vertical position above the cuvette, push the plunger down into the syringe, the desired volume has been delivered into the cuvette.

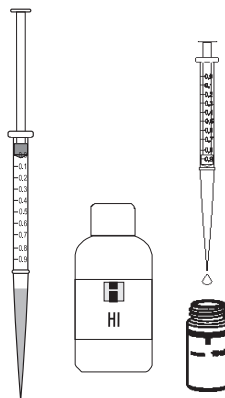

6.2.2. PROPER USE OF DROPPER

- For reproducible results, tap the dropper on the table several times and wipe the outside of the tip with a cloth.
- Always keep the dropper bottle in a vertical position while dosing the reagent.

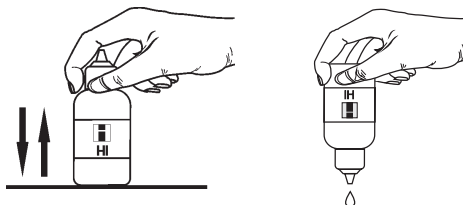

6.2.3. PROPER USE OF POWDER PACKET

- Use scissors to open the powder packet
- Push the edges of the packet to form a spout
- Pour out the content of the packet.

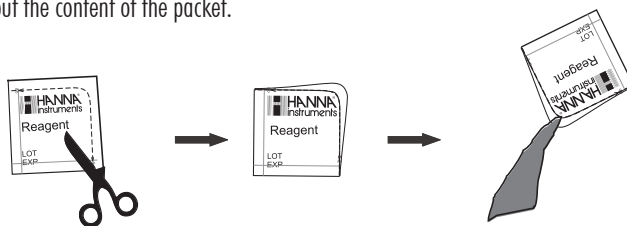

6.3. CUVETTE PREPARATION

Proper mixing is very important for reproducibility of the measurements. The proper mixing technique for each method is listed in the method procedure.

- (a) Invert the cuvette a couple of times or for a specified time: hold the cuvette in the vertical position. Turn the cuvette upside-down and wait for all of the solution to flow to the cap end, then return the cuvette to the upright vertical position and wait for all of the solution to flow to the cuvette bottom. This is one inversion. The correct speed for this mixing technique is 10-15 complete inversions in 30 seconds.

This mixing technique is indicated with “invert to mix” and the following icon:

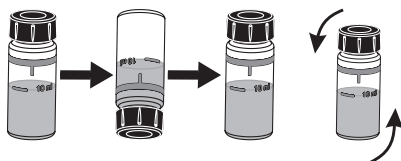

- (b) Shaking the cuvette, moving the cuvette up and down. The movement may be gentle or vigorous. This mixing method is indicated with “shake gently” or “shake vigorously”, and one of the following icons:

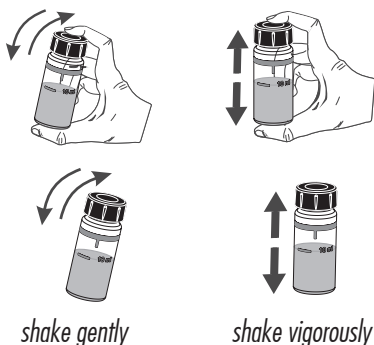

In order to avoid reagent leaking and to obtain more accurate measurements, close the cuvette first with the supplied HDPE plastic stopper  and then the black cap.

Whenever the cuvette is placed into the measurement holder, it must be dry outside and free of fingerprints, oil or dirt. Wipe it thoroughly with [HI731318](#) or a lint-free cloth prior to insertion.

Shaking the cuvette can generate bubbles in the sample, causing higher readings. To obtain accurate measurements, remove such bubbles by swirling or by gently tapping the cuvette.



Do not let the reacted sample stand too long after reagent is added. For best accuracy, respect the timings described in each specific method.

It is possible to take multiple readings in a row, but it is recommended to take a new zero reading for each sample and to use the same cuvette for zeroing and measurement when possible.

Discard the sample immediately after the reading is taken, or the glass might become permanently stained.

All the reaction times reported in this manual are at 25 °C (77 °F). In general, the reaction time should be increased for temperatures lower than 20 °C (68 °F), and decreased for temperatures higher than 25 °C (77 °F).

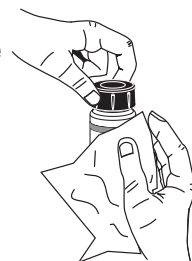

Interference

In the method measurement section the most common interferences that may be present in a typical water sample have been reported. It is possible that a particular application could introduce other compounds that will also interfere.

6.4. TIMERS AND MEASUREMENT FUNCTIONS

Each method requires a different preparation procedure, reaction times, sample preparations, etc. If a timer or timers are necessary for proper sample preparation, the **Timer** key will be available.

To use a reaction timer, press the **Timer** key.

The default timer will start immediately. To stop and reset the timer, press **Stop**.

If the selected method requires more than one timer, the meter will automatically select each timer in the appropriate order. To bypass the default order, you may press the desired key to activate a different timer (only while the current timer is stopped). Press **Continue** to start the active timer.

For some methods, the timer is only necessary after a **Zero** measurement has been performed. In this case, the timer key will only be available after the **Zero** measurement has been performed.

If the method requires a **Zero** or **Read** measurement after a timer has expired, the meter will automatically perform the appropriate action. Follow the instructions in the Method Procedure.

To perform a **Zero** or **Read** measurement, insert the appropriate prepared cuvette, then press the **Zero** or **Read** key. A **Zero** measurement must be conducted before **Read** measurements.

6.5. CHEMICAL FORMULA / UNIT CONVERSION

Chemical formula/unit conversion factors are pre-programmed into the instrument and are method specific. In order to view the displayed result in the desired chemical formula press ▲ ▼ keys to access the second level function and then press the **Chem Frm** key to toggle between the available chemical formulas for the selected method.

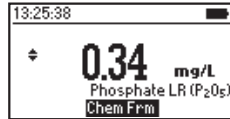
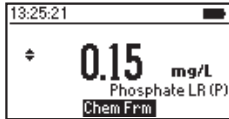

6.6. METER VALIDATION / CAL CHECK

WARNING: Do not validate the meter with standard solutions other than the HANNA® CAL Check Standards. For accurate validation results, please perform tests at room temperature (18 to 25 °C; 64.5 to 77.0 °F).

Validation of the **HI83300** involves absorbance measurements of certified HANNA® CAL Check Standards (see “Accessories”). The “CAL Check” screen guides the user through the measurement of each CAL Check Standard and applies the factory calibration corrections to each measurement. The **HI83300** stores the results of the most recent CAL Check measurements which may be viewed on the “CAL Check” screen. Compare these results with the values printed on the Certificate provided with each HANNA® CAL Check Standards kit.

To perform a validation:

1. Press **Setup** button.
2. Highlight **CAL Check**, then press **Select**.

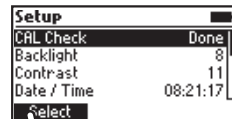

3. Follow the prompts on the screen. The meter will prompt to measure each cuvette provided in the HANNA® CAL Check Standards kit. To abort the process at any time, press **ESC** button.

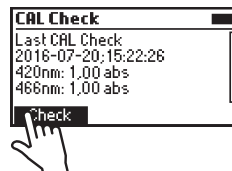

4. Press **ESC** to return in **Setup** menu.



6.7. ABSORBANCE MEASUREMENTS

Raw absorbance measurements may be performed on the **HI83300** for personal or diagnostic purposes. For example, you may monitor the stability of a reagent blank by occasionally measuring its absorbance versus deionized water.

To measure the raw absorbance of a prepared sample:

1. Enable "Photometer Mode" if necessary by pressing the **MODE** key.



2. Press the **METHOD** key.



3. Highlight the appropriate Absorbance method (according to the wavelength to be used), then press **Select**. Absorbance methods are located at the bottom of the method list.
4. Prepare the sample cuvette according to the method.
5. Insert a cuvette filled with deionized water, then press **Zero**.
6. Insert the prepared sample cuvette, then press **Read**.

WARNING: Never use Absorbance methods for validation using HANNA® CAL Check cuvettes. The factory calibration corrections for CAL Check cuvettes are applied while in CAL Check mode only!

7. PROBE MODE

7.1. pH CALIBRATION

Press **MODE** to enter in pH/ mV measurement mode.



Press **Calibrate** to access electrode calibration functions.

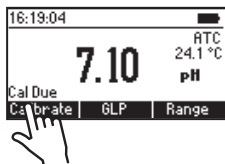

Calibration Mode

While in pH Calibration Mode, the display will show the current pH reading, the current temperature reading, the current selected buffer, and the buffer number ("Buffer: 1" for the 1st buffer, "Buffer: 2" for the 2nd buffer).

The following functions are available in pH Calibration Mode:

- **Clear:** Press to clear the current calibration from the probe.

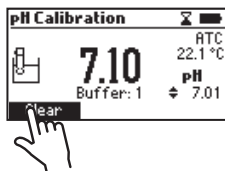

- **Confirm:** Press to accept the current calibration point. Only available if the measurement is stable and within the limits for the selected buffer.

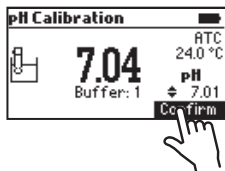

Press to cycle through the list of available buffers: 4.01, 6.86, 7.01, 9.18, 10.01 pH.

Press to exit calibration and return to pH Measurement Mode.

Preparation



Pour small quantities of the buffer solutions into clean beakers. If possible, use plastic beakers to minimize any EMC interferences. For accurate calibration and to minimize cross-contamination, use two beakers for each buffer solution: one for rinsing the electrode and one for calibration. If you are measuring in the acidic range, use pH 7.01 or 6.86 as the first buffer and pH 4.01 as the second buffer. If you are measuring in the alkaline range, use pH 7.01 or 6.86 as the first buffer and pH 10.01 or 9.18 as the second buffer.

Procedure

Calibration can be performed using one or two calibration buffers. For more accurate measurements, a two-point calibration is recommended.

Submerge the pH electrode approximately 3 cm (1¼") into a buffer solution and stir gently. From the Probe Measurement screen, press the **Calibrate** key to begin the calibration process.

When the reading is stable and close to the selected buffer, the **Confirm** key will become available. Press **Confirm** to accept and store the calibration point.

The meter will now prompt for the second buffer ("Buffer: 2"). To use only a one-point calibration, press  to exit calibration mode at this time. The meter will store the calibration information to the probe and return to Measurement mode. To continue calibrating with a second buffer, rinse and submerge the pH electrode approximately 3 cm (1¼") into the second buffer solution and stir gently. If necessary, press  keys to select a different buffer value.



When the reading is stable and close to the selected buffer, the **Confirm** key will become available. Press **Confirm** to accept and store the second calibration point.

The meter will store the two-point calibration information to the probe and return to Measurement mode. The list of calibrated buffers will appear at the bottom of the screen.

7.2. pH CALIBRATION MESSAGES

Clean Probe:

The "Clean Probe" message indicates poor electrode performance (offset out of accepted window, or slope under the accepted lower limit). Often, cleaning the probe will improve the pH electrode's response. See pH Electrode Conditioning and Maintenance for details. Repeat calibration after cleaning.

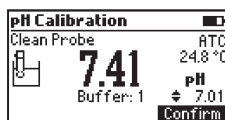

Check Probe & Buffer:

The "Check Probe & Buffer" message appears when there is a large difference between the pH measurement and the selected buffer value, or the electrode slope is outside of the accepted slope limit. You should check your probe and confirm the correct buffer selection. Cleaning may also improve this response.

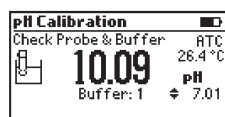

Wrong Temperature:

The buffer temperature is too extreme for the selected buffer value.

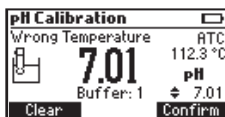

7.3. pH MEASUREMENT

The HI83300 can be used to perform direct pH measurements by connecting a HANNA® digital pH electrode with a 3.5 mm TRRS connector. To begin taking probe measurements, connect the electrode to the 3.5 mm port marked with EXT PROBE located at the rear of the meter. If the meter is in "Photometer Mode", set the meter to "Probe Mode" by pressing the **MODE** key.

While taking pH probe measurements, the following functions are available:

- **Calibrate:** Press to access electrode calibration functions.
- **GLP:** Press to review the last calibration information, including date/time, buffers used, slope, and offset.
- **Range:** Press to switch between "pH" units and "mV" units.

- MODE**
3DEF Press to switch to Photometer mode.
- SETUP**
7PQRS Press to access the meter's Setup menu.
- LOG**
8TUV Press to log the current measurement.
- RECALL**
9WXYZ Press to review the meter's log history.
- HELP**
0,() Press to view contextual help information.

For high accuracy it is recommended to calibrate your electrode often. pH electrodes should be recalibrated at least once per week, but daily calibration is recommended. Always recalibrate after cleaning an electrode. See page 24 for more information on pH calibration.

To take pH measurements:

- Remove the protective cap and rinse the electrode with water.
- Collect some sample in a clean, dry beaker.
- Preferably, rinse the electrode with a small amount of sample. Discard the rinse.
- Submerge the electrode tip approximately 3 cm (1¼") into the sample to be tested and stir the sample gently. Make sure the electrode junction is completely submersed.
- Allow time for the electrode to stabilize in the sample. When the  symbol disappears, your reading is stable.

If measurements are taken successively in different samples, it is recommended to rinse the electrodes thoroughly with deionized or distilled water and then with some of the next sample to prevent cross-contamination.

pH measurements are affected by temperature. HANNA® Digital pH electrodes include a built-in temperature sensor and automatically calculate corrected pH values. The measured temperature is displayed on the screen with the pH measurements.

7.4. pH MEASUREMENT MESSAGES / WARNINGS

No Probe:

No probe is connected or the probe is broken.

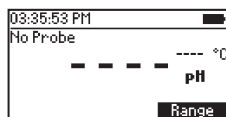

Connecting:

The meter has detected a probe and is reading the probe configuration and calibration information.

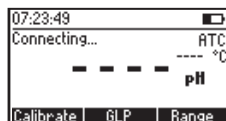

Incompatible Probe:

The connected probe is not compatible with this device.

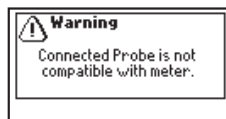

Incompatible Calibration:

The probe's current calibration is not compatible with this meter. The calibration must be cleared to use this probe.

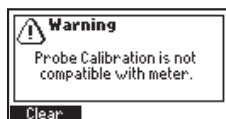

Exceeded Probe Range:

The pH and/or temperature measurement exceed the specifications of the probe. The affected measurement value(s) will be flashing.

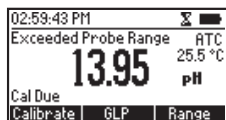

Broken Temperature Sensor:

The temperature sensor inside the probe is broken. Temperature compensation will revert to a fixed value of 25 °C (77 °C).

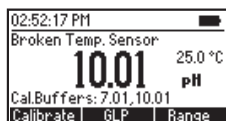

Cal Due:

The probe has no calibration. See section Probe Calibration.

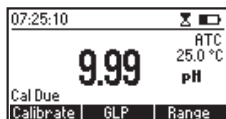

7.5. pH GLP

Good Laboratory Practice (GLP) refers to a quality control function used to ensure uniformity and consistency of sensor calibrations and measurements. To view the GLP information, press the **GLP** key from the Probe Measurement screen.

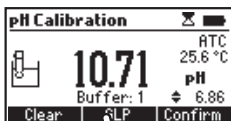

The pH GLP screen displays the following information about the last pH calibration:

- Date and time of the last calibration
- List of buffers used in the last calibration
- Calculated slope and offset

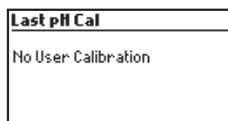
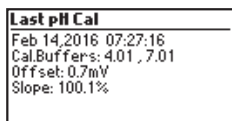

- Press **ESC** to return in measurement mode.



7.6. pH ELECTRODE CONDITIONING AND MAINTENANCE

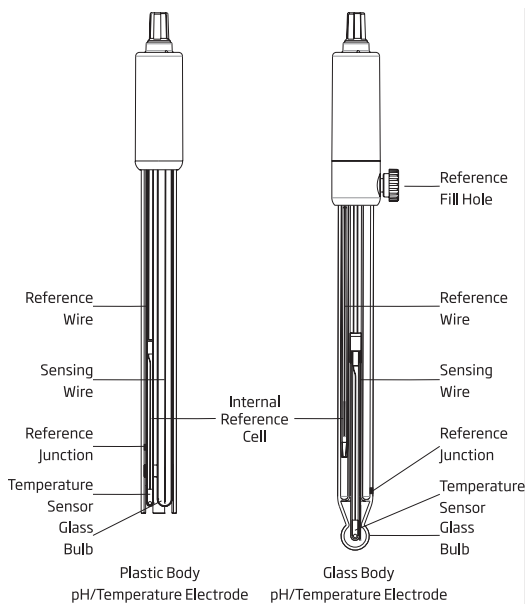

Remove the protective cap of the pH electrode.

DO NOT BE ALARMED IF SALT DEPOSITS ARE PRESENT.

This is normal with electrodes. They will disappear when rinsed with water.

During transport, tiny bubbles of air may form inside the glass bulb affecting proper functioning of the electrode. These bubbles can be removed by “shaking down” the electrode as you would do with a glass thermometer. If the bulb and/or junction is dry, soak the electrode in [HI70300](#) or [HI80300](#) storage solution for at least one hour.

For refillable electrodes:

If the filling solution (electrolyte) is more than 2½ cm (1”) below the fill hole, add [HI7082](#) or [HI8082](#) 3.5M KCl Electrolyte Solution for double junction electrodes.

Unscrew the fill hole cover during measurements so the liquid reference junction maintains an outward flow of electrolyte.

Measurement

Rinse the electrode tip with distilled water. Submerge the tip 3 cm (1¼”) in the sample and stir gently for a few seconds. For a faster response and to avoid cross-contamination of the samples, rinse the electrode tip with a few drops of the solution to be tested, before taking measurements.

Storage Procedure

To minimize clogging and ensure a quick response time, the glass bulb and the junction should be kept moist and not allowed to dry out.

Replace the solution in the protective cap with a few drops of [HI70300](#) or [HI80300](#) Storage Solution or, in its absence, Filling Solution ([HI7082](#) or [HI8082](#) for double junction electrodes). Follow the preparation procedure before taking measurements.

Note: NEVER STORE THE ELECTRODE IN DISTILLED OR DEIONIZED WATER.

Periodic Maintenance

Inspect the electrode and the cable. The cable used for connection to the instrument must be intact and there must be no points of broken insulation on the cable or cracks on the electrode stem or bulb. Connectors must be perfectly clean and dry. If any scratches or cracks are present, replace the electrode. Rinse off any salt deposits with water.

For refillable electrodes: Refill the reference chamber with fresh electrolyte ([HI7082](#) or [HI8082](#) for double junction electrodes). Allow the electrode to stand upright for 1 hour.

Follow the Storage Procedure above.

Cleaning Procedure

Use diagnostic messages to aid pH electrode troubleshooting. Several cleaning solutions are available:

- General — Soak in Hanna [HI7061](#) or [HI8061](#) General Cleaning Solution for approximately ½ hour.
- Protein — Soak in Hanna [HI7073](#) or [HI8073](#) Protein Cleaning Solution for 15 minutes.
- Inorganic — Soak in Hanna [HI7074](#) Inorganic Cleaning Solution for 15 minutes.
- Oil/grease — Rinse with Hanna [HI7077](#) or [HI8077](#) Oil and Fat Cleaning Solution.

Note: After performing any of the cleaning procedures, rinse the electrode thoroughly with distilled water, refill the reference chamber with fresh electrolyte (not necessary for gel-filled electrodes) and soak the electrode in [HI70300](#) or [HI80300](#) Storage Solution for at least 1 hour before taking measurements.

Temperature Correlation For pH Sensitive Glass

Verify the temperature range by reading the limits on electrodes cap. The pH electrode's life also depends on the temperature that is used. If constantly cycled between two temperatures, the life of the electrode is drastically reduced.

8. METHOD PROCEDURES

8.1. ALKALINITY

SPECIFICATIONS

| | |
|--------------|---|
| Range | 0 to 500 mg/L (as CaCO ₃) |
| Resolution | 1 mg/L |
| Accuracy | ± 5 mg/L ± 5% of reading at 25 °C |
| Light Source | LED with narrow band interference filter @ 610 nm |
| Method | Colorimetric Method. |

REQUIRED REAGENTS

| Code | Description | Quantity |
|------------|--------------------------|----------|
| HI775S | Alkalinity Reagent | 1 mL |
| HI93755-53 | Chlorine Removal Reagent | 1 drop |

REAGENT SETS

HI775-26 Reagents for 25 tests
 For other accessories see page 200.

MEASUREMENT PROCEDURE

- Select the **Alkalinity** method using the procedure described in the Method Selection section (see page 18).
- Fill the cuvette with 10 mL of unreacted sample (up to the mark) and replace the cap.
- Place the cuvette into the holder and close the lid.

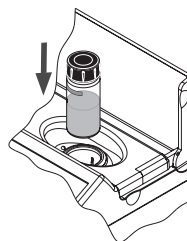

- Press the **Zero** key. The display will show “-0.0-” when the meter is zeroed and ready for measurement.

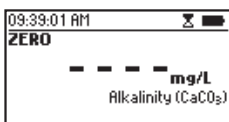
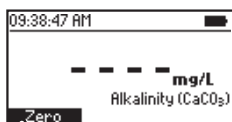

- Remove the cuvette.

Note: Any chlorine present in the sample will interfere with the reading. To remove the chlorine interference add one drop of HI93755-53 Chlorine Removal Reagent to the unreacted sample.

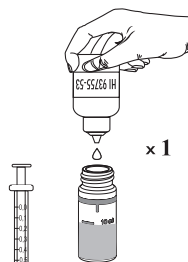

- Add 1 mL of HI775S Alkalinity Reagent to the sample using a 1 mL syringe.



- Replace the cap and invert 5 times.



- Reinsert the cuvette into the instrument and close the lid.

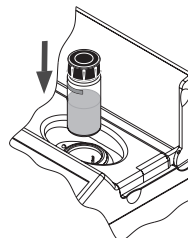

- Press **Read** to start the reading. The instrument displays the results in mg/L calcium carbonate (CaCO₃).

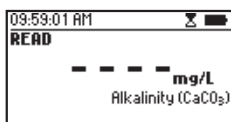

8.2. ALKALINITY, MARINE

SPECIFICATIONS

| | |
|--------------|---|
| Range | 0 to 300 mg/L (as CaCO ₃) |
| Resolution | 1 mg/L |
| Accuracy | ± 5 mg/L ± 5% of reading at 25 °C |
| Light Source | LED with narrow band interference filter @ 610 nm |
| Method | Colorimetric Method. |

REQUIRED REAGENTS

| Code | Description | Quantity |
|--------|--------------------|----------|
| HI755S | Alkalinity Reagent | 1 mL |

REAGENT SETS

HI755-26 Reagents for 25 tests
 For other accessories see page 200.

MEASUREMENT PROCEDURE

- Select the **Alkalinity Marine** method using the procedure described in the Method Selection section (see page 18).
- Fill the cuvette with 10 mL of unreacted sample (up to the mark) and replace the cap.



- Place the cuvette into the holder and close the lid.

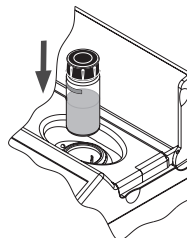

- Press the **Zero** key. The display will show “-0.0-” when the meter is zeroed and ready for measurement.

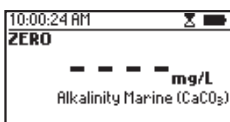
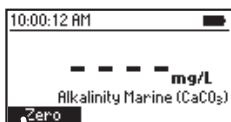

- Remove the cuvette.
- Add 1 mL of HI755S Alkalinity Reagent to the sample using a 1 mL syringe.

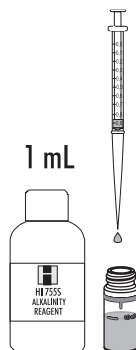

- Replace the cap and gently invert 5 times.

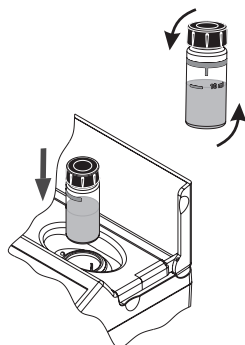

- Reinsert the cuvette into the instrument and close the lid.
- Press **Read** to start the reading. The instrument displays the results in mg/L as calcium carbonate (CaCO_3).

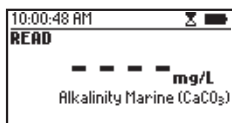

- Press ▲ or ▼ to access the second level functions.
- Press **Chem Frm** key to convert the result to degree KH (dKH).

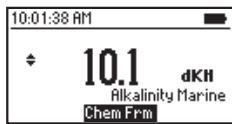

- Press ▲ or ▼ to return to the measurement screen.

8.3. ALUMINUM

SPECIFICATIONS

| | |
|--------------|---|
| Range | 0.00 to 1.00 mg/L (as Al ³⁺) |
| Resolution | 0.01 mg/L |
| Accuracy | ±0.04 mg/L ±4% of reading at 25 °C |
| Light Source | LED with narrow band interference filter @ 525 nm |
| Method | Adaptation of the aluminon method. |

REQUIRED REAGENTS

| Code | Description | Quantity |
|------------|--------------------|----------|
| HI93712A-0 | Aluminum Reagent A | 1 packet |
| HI93712B-0 | Aluminum Reagent B | 1 packet |
| HI93712C-0 | Aluminum Reagent C | 1 packet |

REAGENT SETS

| | |
|------------|------------------------|
| HI93712-01 | Reagents for 100 tests |
| HI93712-03 | Reagents for 300 tests |

For other accessories see page 200.

MEASUREMENT PROCEDURE

- Select the **Aluminum** method using the procedure described in the Method Selection section (see page 18).
- Fill a graduated beaker with 50 mL of sample.
- Add one packet of **HI93712A-0** Aluminum Reagent A and mix until completely dissolved.
- Add one packet of **HI93712B-0** Aluminum Reagent B and mix until completely dissolved.



- Fill two cuvettes with 10 mL of sample (up to the mark).



- Add one packet of HI93712C-0 Aluminum Reagent C to one cuvette (#1). Replace the cap and shake gently until completely dissolved. This is the blank.

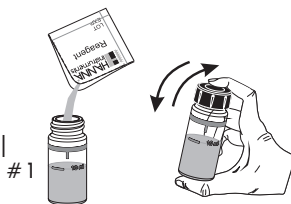

- Place the first cuvette (#1) into the holder and close the lid.

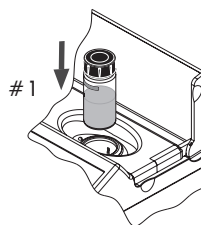

- Press **Timer** and the display will show the countdown prior to zeroing the blank. Alternatively wait for 15 minutes and then press **Zero**. The display will show “-0.0-” when the meter is zeroed and ready for measurement.

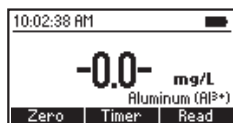
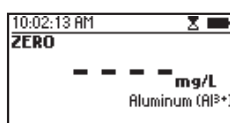
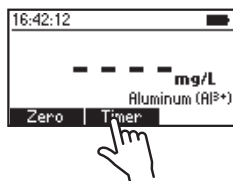

- Remove the blank and insert the second cuvette (#2) into the instrument and close the lid.

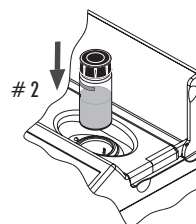

- Press the **Read** key to start the reading. The instrument displays the results in **mg/L of aluminum (Al^{3+})**.

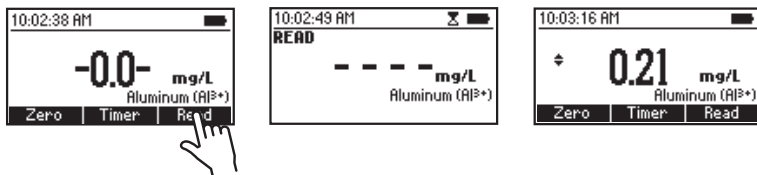

- Press **▲** or **▼** to access the second level functions.
- Press the **Chem Frm** key to convert the result to **mg/L of aluminum oxide (Al_2O_3)**.

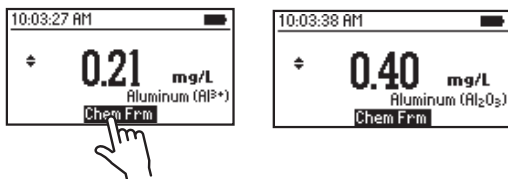

- Press **▲** or **▼** to return to the measurement screen.

INTERFERENCES

Interference may be caused by:

Iron above 20 mg/L

Alkalinity above 1000 mg/L

Phosphate above 50 mg/L

Fluoride must be absent

8.4. AMMONIA LOW RANGE

SPECIFICATIONS

| | |
|--------------|--|
| Range | 0.00 to 3.00 mg/L (as NH ₃ -N) |
| Resolution | 0.01 mg/L |
| Accuracy | ±0.04 mg/L ±4% of reading at 25 °C |
| Light Source | LED with narrow band interference filter @ 420 nm |
| Method | Adaptation of the ASTM Manual of Water and Environmental Technology, D1426 Nessler method. |

REQUIRED REAGENTS

| Code | Description | Quantity |
|------------|-----------------------------|----------|
| HI93700A-0 | Ammonia Low Range Reagent A | 4 drops |
| HI93700B-0 | Ammonia Low Range Reagent B | 4 drops |

REAGENT SETS

| | |
|------------|------------------------|
| HI93700-01 | Reagents for 100 tests |
| HI93700-03 | Reagents for 300 tests |

For other accessories see page 200.

MEASUREMENT PROCEDURE

- Select the **Ammonia LR** method using the procedure described in the Method Selection section (see page 18).



- Fill the cuvette with 10 mL of unreacted sample (up to the mark) and replace the cap.

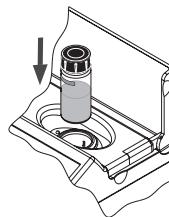

- Place the cuvette into the holder and close the lid.

- Press the **Zero** key. The display will show “-0.0-” when the meter is zeroed and ready for measurement.

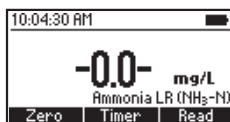
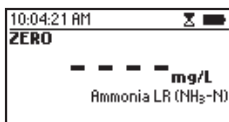
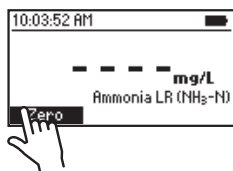

- Remove the cuvette.

- Add 4 drops of HI93700A-0 Ammonia Low Range Reagent A. Replace the cap and mix the solution.

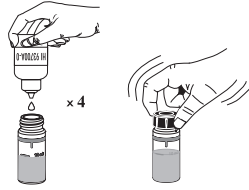

- Add 4 drops of HI93700B-0 Ammonia Low Range Reagent B. Replace the cap and mix the solution.

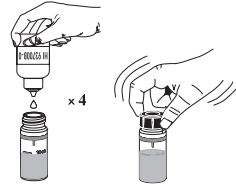

- Reinsert the cuvette into the instrument and close the lid.

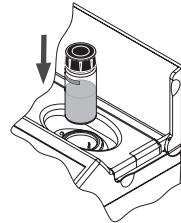

- Press **Timer** and the display will show the countdown prior to the measurement or, alternatively, wait for 3 minutes and 30 seconds and press **Read**. When the timer ends the meter will perform the reading. The instrument displays the results in **mg/L of ammonia nitrogen (NH₃-N)**.

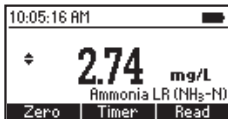
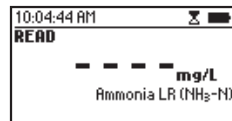
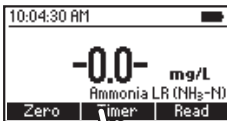

- Press ▲ or ▼ to access the second level functions.
- Press the Chem Frm key to convert the result to mg/L of ammonia (NH_3) and ammonium (NH_4^+).

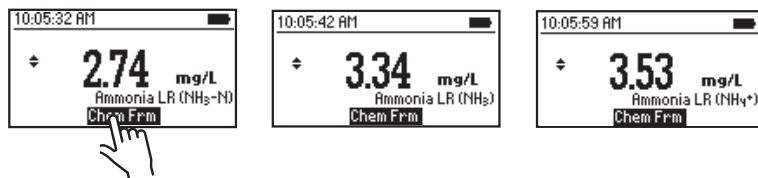

- Press ▲ or ▼ to return to the measurement screen.

INTERFERENCE

Interference may be caused by:

Acetone

Alcohols

Aldehydes

Glycine

Hardness above 1 g/L

Iron

Organic chloramines

Sulfide

Various aliphatic and aromatic amines

8.5. AMMONIA MEDIUM RANGE

SPECIFICATIONS

| | |
|--------------|---|
| Range | 0.00 to 10.00 mg/L (as NH ₃ -N) |
| Resolution | 0.01 mg/L |
| Accuracy | ±0.05 mg/L ±5% of reading at 25 °C |
| Light Source | LED with narrow band interference filter @ 420 nm |
| Method | Adaptation of the ASTM Manual of Water and Environmental Technology, D1426, Nessler method. |

REQUIRED REAGENTS

| Code | Description | Quantity |
|------------|--------------------------------|----------|
| HI93715A-0 | Ammonia Medium Range Reagent A | 4 drops |
| HI93715B-0 | Ammonia Medium Range Reagent B | 4 drops |

REAGENT SETS

| | |
|------------|------------------------|
| HI93715-01 | Reagents for 100 tests |
| HI93715-03 | Reagents for 300 tests |

For other accessories see page 200.

MEASUREMENT PROCEDURE

- Select the **Ammonia MR** method using the procedure described in the Method Selection section (see page 18).
- Fill the cuvette with 10 mL of unreacted sample (up to the mark) and replace the cap.
- Place the cuvette into the holder and close the lid.
- Press the **Zero** key. The display will show “-0.0-” when the meter is zeroed and ready for measurement.

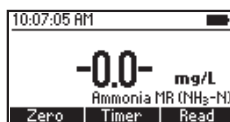
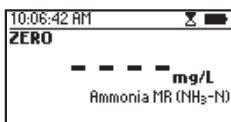
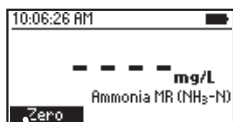
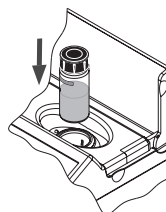

- Remove the cuvette.
- Add 4 drops of HI93715A-0 Ammonia Medium Range Reagent A. Replace the cap and mix the solution.

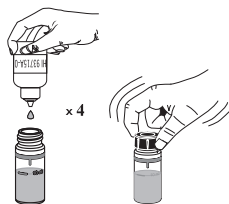

- Add 4 drops of HI93715B-0 Ammonia Medium Range Reagent B. Replace the cap and mix the solution.

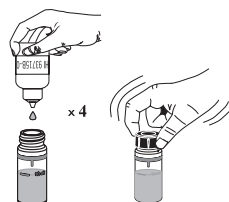

- Reinsert the cuvette into the instrument and close the lid.

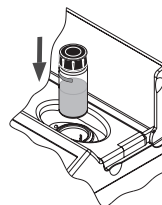

- Press **Timer** and the display will show the countdown prior to the measurement or, alternatively, wait for 3 minutes and 30 seconds and press **Read**. When the timer ends the meter will perform the reading. The instrument displays the results to **mg/L of ammonia nitrogen (NH₃-N)**.

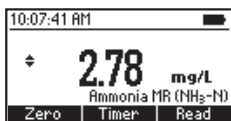
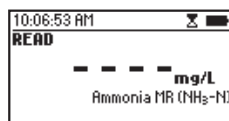

- Press ▲ or ▼ to access the second level functions.

- Press the **Chem Frm** key to convert the result in mg/L of ammonia (NH_3) and ammonium (NH_4^+).

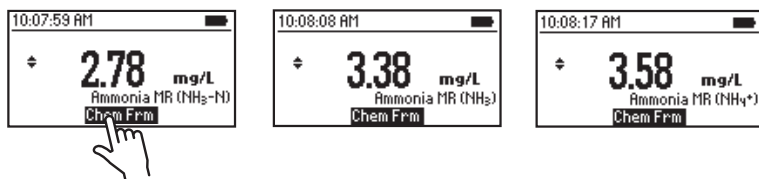

- Press **▲** or **▼** to return to the measurement screen.

INTERFERENCES

Interference may be caused by:

- Acetone
- Alcohols
- Aldehydes
- Glycine
- Hardness above 1 g/L
- Iron
- Organic chloramines
- Sulfide
- Various aliphatic and aromatic amines

8.6. AMMONIA HIGH RANGE

SPECIFICATIONS

| | |
|--------------|---|
| Range | 0.0 to 100.0 mg/L (as NH ₃ -N) |
| Resolution | 0.1 mg/L |
| Accuracy | ±0.5 mg/L ±5% of reading at 25 °C |
| Light Source | LED with narrow band interference filter @ 420 nm |
| Method | Adaptation of the ASTM Manual of Water and Environmental Technology, D1426, Nessler method. |

REQUIRED REAGENTS

| Code | Description | Quantity |
|------------|------------------------------|----------|
| HI93733A-0 | Ammonia High Range Reagent A | 4 drops |
| HI93733B-0 | Ammonia High Range Reagent B | 9 mL |

REAGENT SETS

| | |
|------------|------------------------|
| HI93733-01 | Reagents for 100 tests |
| HI93733-03 | Reagents for 300 tests |

For other accessories see page 200.

MEASUREMENT PROCEDURE

- Select the **Ammonia HR** method using the procedure described in the Method Selection section (see page 18).
- Add 1 mL of unreacted sample to the cuvette using 1 mL syringe.
- Use the pipette to fill the cuvette up to the 10 mL mark with **HI93733B-0** Ammonia High Range Reagent B. Replace the cap and mix the solution.
- Place the cuvette into the holder and close the lid.

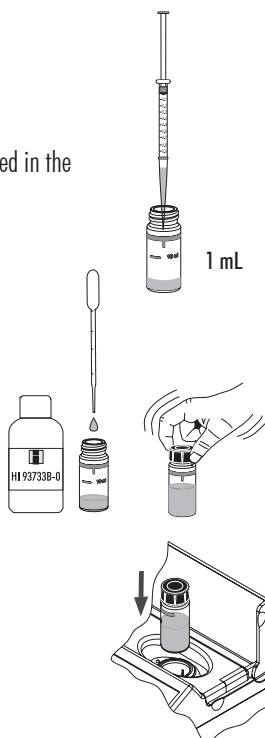

- Press the **Zero** key. The display will show “-0.0-” when the meter is zeroed and ready for measurement.

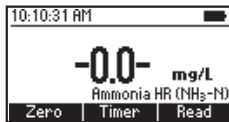
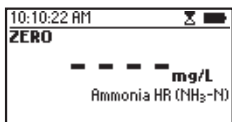
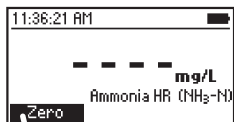

- Remove the cuvette.
- Add 4 drops of **HI93733A-0** Ammonia High Range Reagent A. Replace the cap and swirl the solution.

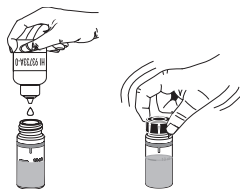

- Reinsert the cuvette into the instrument and close the lid.

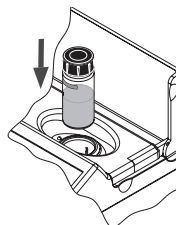

- Press **Timer** and the display will show the countdown prior to the measurement or, alternatively, wait for 3 minutes and 30 seconds and press **Read**. When the timer ends the meter will perform the reading. The instrument displays the results in **mg/L of ammonia nitrogen (NH₃-N)**.

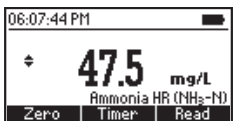
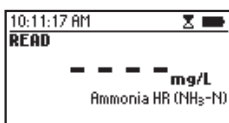
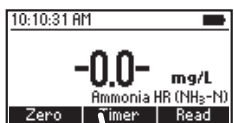

- Press **▲** or **▼** to access the second level functions.

- Press the **Chem Frm** key to convert the result to mg/L of ammonia (NH_3) and ammonium (NH_4^+).

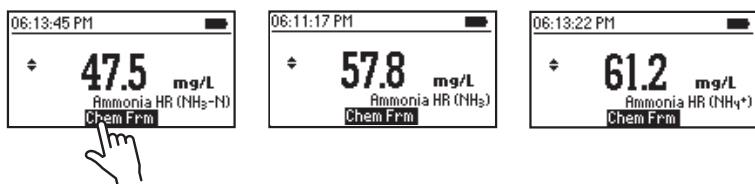

- Press **▲** or **▼** to return to the measurement screen.

INTERFERENCES

Interference may be caused by:

Acetone

Alcohols

Aldehydes

Glycine

Hardness above 1 g/L

Iron

Organic chloramines

Sulfide

Various aliphatic and aromatic amines

8.7. BROMINE

SPECIFICATIONS

| | |
|--------------|---|
| Range | 0.00 to 8.00 mg/L (as Br ₂) |
| Resolution | 0.01 mg/L |
| Accuracy | ±0.08 mg/L ± 3% of reading at 25 °C |
| Light Source | LED with narrow band interference filter @ 525 nm |
| Method | Adaptation of the Standard Methods for the Examination of Water and Wastewater, 18th edition, DPD method. |

REQUIRED REAGENTS

| Code | Description | Quantity |
|-----------|-----------------|----------|
| HI93716-0 | Bromine Reagent | 1 packet |

REAGENT SETS

HI93716-01 Reagents for 100 tests

HI93716-03 Reagents for 300 tests

For other accessories see page 200.

MEASUREMENT PROCEDURE

- Select the **Bromine** method using the procedure described in the Method Selection section (see page 18).
- Fill the cuvette with 10 mL of unreacted sample (up to the mark) and replace the cap.
- Place the cuvette into the holder and close the lid.
- Press the **Zero** key. The display will show “-0.0-” when the meter is zeroed and ready for measurement.

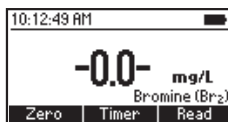
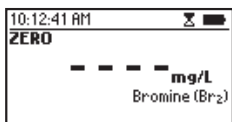
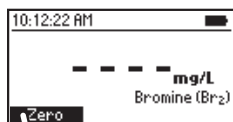
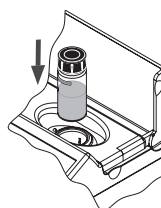

- Remove the cuvette.
- Add one packet of **HI93716-0** Bromine Reagent. Replace the cap and shake gently for about 20 seconds to dissolve most of the reagent.

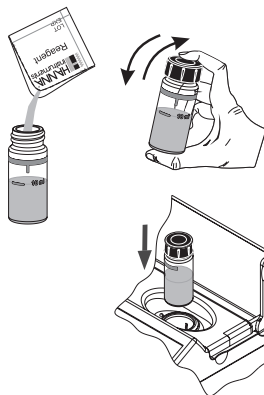

- Reinsert the cuvette into the instrument and close the lid.
- Press **Timer** and the display will show the countdown prior to the measurement or, alternatively, wait for 2 minutes and 30 seconds and press **Read**. When the timer ends the meter will perform the reading. The instrument displays the results in **mg/L of bromine (Br₂)**.

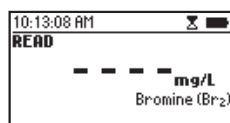
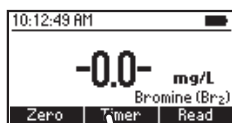

INTERFERENCES

Interference may be caused by: Chlorine, Iodine, Ozone, Oxidized forms of Chromium and Manganese. In case of water with hardness greater than 500 mg/L CaCO₃, shake the sample for approximately 1 minute after adding the reagent.

In case of water with alkalinity greater than 300 mg/L CaCO₃ or acidity greater than 150 mg/L CaCO₃, the color of the sample may develop only partially, or may rapidly fade. To resolve this, neutralize the sample with diluted HCl or NaOH.

8.8. CALCIUM

SPECIFICATIONS

| | |
|--------------|---|
| Range | 0 to 400 mg/L (as Ca ²⁺) |
| Resolution | 1 mg/L |
| Accuracy | ±10 mg/L ±5% of reading at 25 °C |
| Light Source | LED with narrow band interference filter @ 466 nm |
| Method | Adaptation of the Oxalate method. |

REQUIRED REAGENTS

| Code | Description | Quantity |
|-------------|-------------------|----------|
| - | Buffer Reagent | 4 drops |
| HI93752A-Ca | Calcium Reagent A | 7 mL |
| HI93752B-Ca | Calcium Reagent B | 1 mL |

REAGENT SETS

| | |
|-------------|------------------------|
| HI937521-01 | Reagents for 50 tests |
| HI937521-03 | Reagents for 150 tests |

For other accessories see page 200.

MEASUREMENT PROCEDURE

- Select the **Calcium** method using the procedure described in the Method Selection section (see page 18).

- Add 3 mL of unreacted sample to the cuvette using the 5 mL syringe.

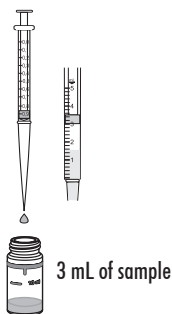

- Use the pipette to fill the cuvette up to the 10 mL mark with the **HI93752A-Ca** Calcium Reagent A.

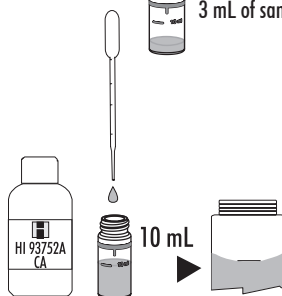

- Add 4 drops of Buffer Reagent.

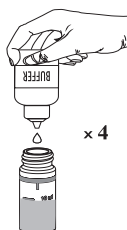

- Replace the cap and invert several times to mix.

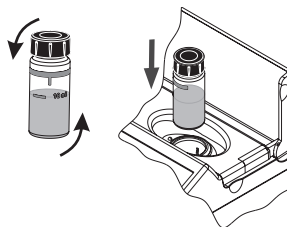

- Place the cuvette into the holder and close the lid.

- Press the **Zero** key. The display will show “-0.0-” when the meter is zeroed and ready for measurement.

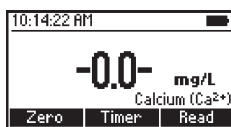
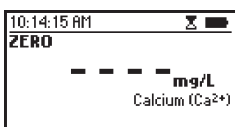
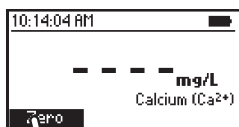

- Remove the cuvette.

- Add 1 mL of **HI93752B-Ca** Calcium Reagent B to the sample using the 1 mL syringe. Invert the cuvette 10 times to mix (about 15 seconds).

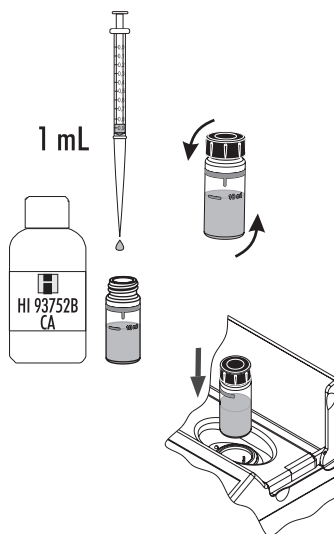

- Reinsert the cuvette into the instrument.

- Press **Timer** and the display will show the countdown prior to the measurement or, alternatively, wait for 5 minutes.

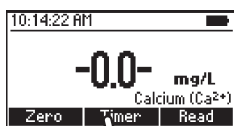

- After waiting 5 minutes, invert again the cuvette 10 times to mix (about 15 seconds).

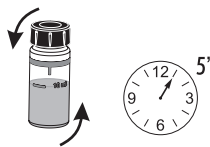

- Reinsert the cuvette into the instrument and close the lid.

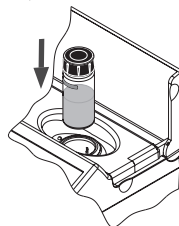

- Press **Read** to start the reading. The instrument displays the results in **mg/L of calcium (Ca²⁺)**.

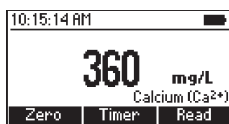
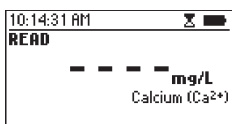
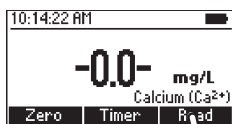

INTERFERENCES

Interferences may be caused by:

Acidity (as CaCO₃) above 1000 mg/L

Alkalinity (as CaCO₃) above 1000 mg/L

Magnesium (Mg²⁺) above 400 mg/L

8.9. CALCIUM, MARINE

SPECIFICATIONS

| | |
|--------------|---|
| Range | 200 to 600 mg/L (as Ca ²⁺) |
| Resolution | 1 mg/L |
| Accuracy | ±6% of reading at 25 °C |
| Light Source | LED with narrow band interference filter @ 610 nm |
| Method | Adaptation of the Zincon method. |

REQUIRED REAGENTS

| Code | Description | Quantity |
|--------|-------------------|----------|
| HI7581 | Calcium Reagent A | 1 mL |
| HI7582 | Calcium Reagent B | 1 packet |

REAGENT SETS

HI758-26 Reagents for 25 tests

For other accessories see page 200.

MEASUREMENT PROCEDURE

- Select the **Calcium Marine** method using the procedure described in the Method Selection section (see page 18).

- Add 1 mL of **HI7581** Calcium Reagent A to the cuvette using a 1 mL syringe.

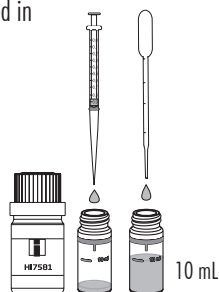

- Use the plastic pipette to fill the cuvette to the 10 mL mark with deionized water and replace the cap. Invert 3-5 times to mix.

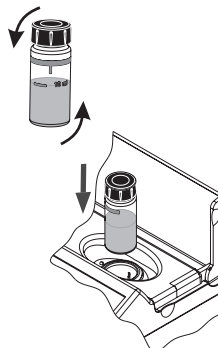

- Place the cuvette into the holder and close the lid.

- Press the **Zero** key. The display will show “-0.0-” when the meter is zeroed and ready for measurement.

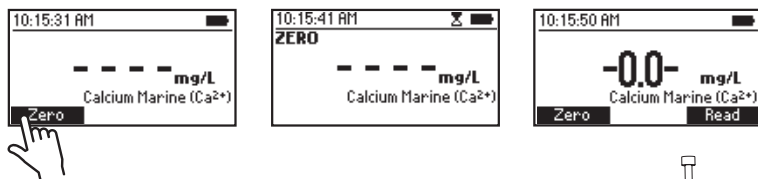

- Remove the cuvette.
- Use the minipipette to add 0.1 mL of sample to the cuvette.

- Add one packet of **HI7582** Calcium Reagent B. Replace the cap and shake vigorously for 15 seconds or until the powder is completely dissolved. Allow air bubbles to dissipate for 15 seconds before taking a reading.

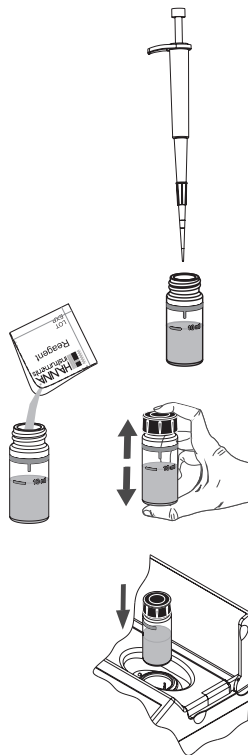

- Reinsert the cuvette into the instrument and close the lid.

- Press **Read** to start the reading. The instrument displays the results in **mg/L of calcium (Ca²⁺)**.

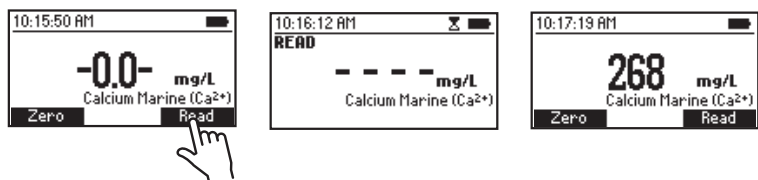

8.10. CHLORIDE

SPECIFICATIONS

| | |
|--------------|--|
| Range | 0.0 to 20.0 mg/L (as Cl ⁻) |
| Resolution | 0.1 mg/L |
| Accuracy | ±0.5 mg/L ±6% of reading at 25 °C |
| Light Source | Light Emitting Diode with narrow band interference filter @ 466 nm |
| Method | Adaptation of the mercury(II) thiocyanate method. |

REQUIRED REAGENTS

| Code | Description | Quantity |
|------------|--------------------|----------|
| HI93753A-0 | Chloride Reagent A | 1 mL |
| HI93753B-0 | Chloride Reagent B | 1 mL |

REAGENT SETS

HI93753-01 Reagents for 100 tests

HI93753-03 Reagents for 300 tests

For other accessories see page 200.

MEASUREMENT PROCEDURE

- Select the **Chloride** method using the procedure described in the Method Selection section (see page 18).

- Fill one cuvette (#1) with 10 mL of deionized water (up to the mark).



- Fill another cuvette (#2) with 10 mL of sample (up to the mark).

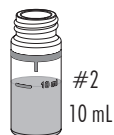

Notes: • For samples with low chloride ion concentration, rinse the cuvette a few times with sample before filling it with 10 mL of sample.

- For the most accurate results, use two graduated pipettes to deliver exactly 10 mL of deionized water and 10 mL of sample to the cuvettes.

- Add 0.5 mL of **HI93753A-0** Chloride Reagent A to each cuvette using the 1 mL syringe

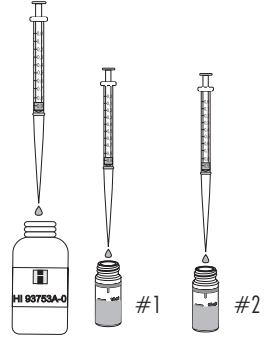

- Replace the caps and mix each cuvette by inverting for approximately 30 seconds.



- Add 0.5 mL of **HI93753B-0** Chloride Reagent B to each cuvette using the second 1 mL syringe.

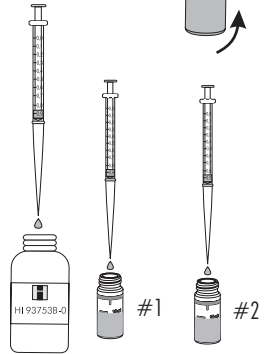

- Replace the caps and mix each cuvette by inverting for approximately 30 seconds.



- Place the cuvette with the reacted deionized water (#1) into the holder and close the lid.

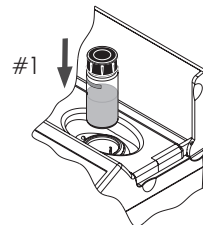

- Press **Timer** and the display will show the countdown prior to the zero or, alternatively, wait for 2 minutes and press **Zero**. The display will show "-0.0-" when the meter is zeroed and ready for measurement.

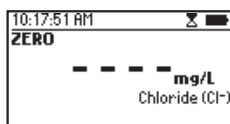
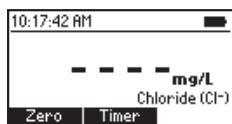

- Remove the cuvette.
- Insert the other cuvette (# 2) with the reacted sample into the instrument and close the lid.

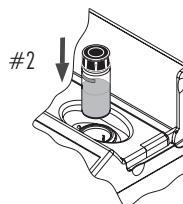

- Press **Read** to start reading. The instrument displays the results in **mg/L of chloride (Cl⁻)**.

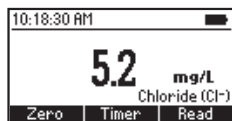
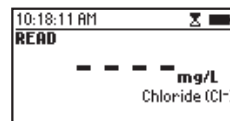
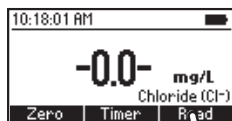

INTERFERENCES

Interference may be caused by:

For alkaline samples, neutralize before adding reagents. The pH of the sample after addition of reagents should be about 2.

Intensely colored samples will cause interference, therefore they should be adequately treated before performing the test. Suspended matter in large amount should be removed by prior filtration.

8.11. CHLORINE DIOXIDE

SPECIFICATIONS

| | |
|--------------|---|
| Range | 0.00 to 2.00 mg/L (as ClO ₂) |
| Resolution | 0.01 mg/L |
| Accuracy | ±0.10 mg/L ±5% of reading at 25 °C |
| Light Source | LED with narrow band interference filter @ 575 nm |
| Method | Adaptation of the Chlorophenol Red method. |

REQUIRED REAGENT

| Code | Description | Quantity |
|------------|----------------------------|----------|
| HI93738A-0 | Chlorine Dioxide Reagent A | 1 mL |
| HI93738B-0 | Chlorine Dioxide Reagent B | 1 packet |
| HI93738C-0 | Chlorine Dioxide Reagent C | 1 mL |
| HI93738D-0 | Chlorine Dioxide Reagent D | 1 mL |

REAGENT SETS

| | |
|------------|------------------------|
| HI93738-01 | Reagents for 100 tests |
| HI93738-03 | Reagents for 300 tests |

For other accessories see page 200.

MEASUREMENT PROCEDURE

- Select the **Chlorine Dioxide** method using the procedure described in the Method Selection section (see page 18).
- Fill two graduated mixing cylinders (#1 & #2) up to the 25 mL mark with the sample.
- Add 0.5 mL of **HI93738A-0** Chlorine Dioxide Reagent A to each cylinder (#1 & #2), using a 1 mL syringe, cap them and invert several times to mix.

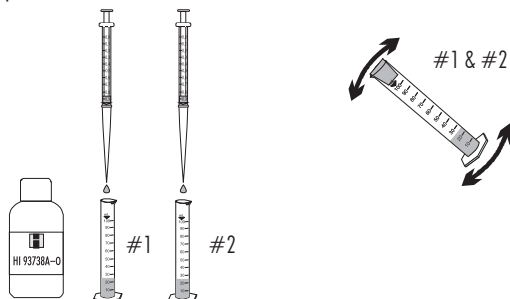
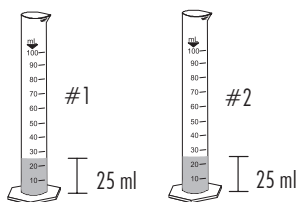

- Add one packet of **HI93738B-0** Chlorine Dioxide Reagent B to one of the two cylinders (#1), cap and invert several times until it is totally dissolved. This is the blank.



- Add 0.5 mL of **HI93738C-0** Chlorine Dioxide Reagent C to each cylinder (#1 & #2), using a 1 mL syringe, cap, and invert several times to mix.

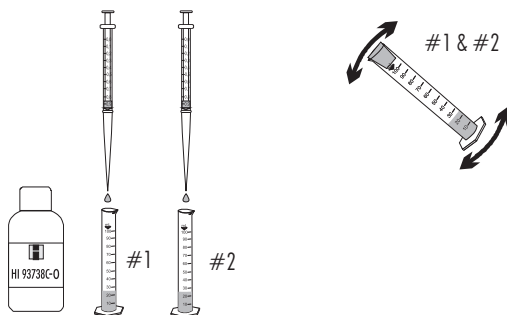

- Add 0.5 mL of **HI93738D-0** Chlorine Dioxide Reagent to each cylinder (#1 & #2), using a 1 mL syringe, cap and invert several times to mix. Cylinder #2 is the reacted sample.

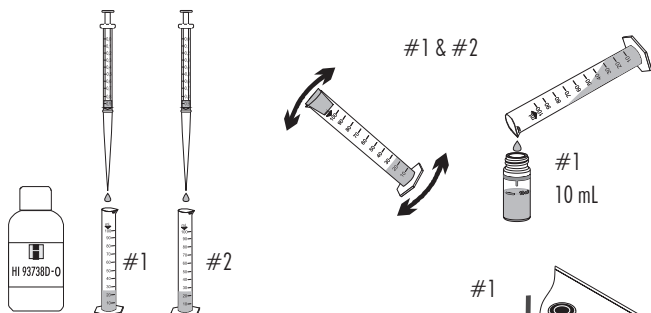

- Fill cuvette (#1) with 10 mL of the blank (up to the mark) and replace the cap.
- Place the blank (#1) into the holder and close the lid.

- Press the **Zero** key. The display will show “-0.0-” when the meter is zeroed and ready for measurement.

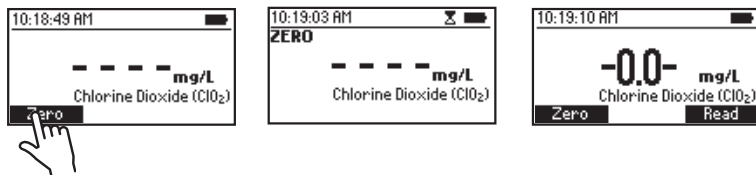

- Fill second cuvette (#2) with 10 mL of the reacted sample (up to the mark) and replace the cap.



- Insert the sample into the instrument and close the lid.

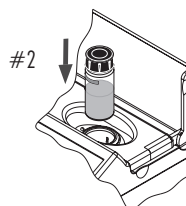

- Press **Read** to start the reading. The instrument displays the results in **mg/L of chlorine dioxide (ClO₂)**.

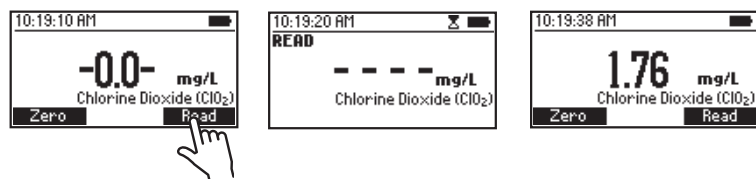

SAMPLING PROCEDURE

It is recommended to analyze chlorine dioxide samples immediately after collection. Chlorine Dioxide samples must be stored in sealed dark glass bottle, with minimal head space. Excessive heat (above 25 °C/77 °F), agitation and exposure to light must be avoided.

INTERFERENCES

Interferences may be caused by strong oxidants.

8.12. CHLORINE, FREE

SPECIFICATIONS

| | |
|--------------|---|
| Range | 0.00 to 5.00 mg/L (as Cl ₂) |
| Resolution | 0.01 mg/L |
| Accuracy | ±0.03 mg/L ±3% of reading at 25 °C |
| Light Source | LED with narrow band interference filter @ 525 nm |
| Method | Adaptation of the EPA DPD method 330.5. |

REQUIRED REAGENTS

POWDER:

| Code | Description | Quantity |
|-----------|-----------------------|----------|
| HI93701-0 | Free Chlorine Reagent | 1 packet |

LIQUID:

| Code | Description | Quantity |
|------------|-------------------------|----------|
| HI93701A-F | Free Chlorine Reagent A | 3 drops |
| HI93701B-F | Free Chlorine Reagent B | 3 drops |

REAGENT SETS

| | |
|------------|---------------------------------|
| HI93701-F | Reagents for 300 tests (liquid) |
| HI93701-01 | Reagents for 100 tests (powder) |
| HI93701-03 | Reagents for 300 tests (powder) |

For other accessories see page 200.

MEASUREMENT PROCEDURE

- Select the **Chlorine (Free)** method using the procedure described in the Method Selection section (see page 18).
- Fill the cuvette with 10 mL of unreacted sample (up to the mark) and replace the cap.
- Place the cuvette into the holder and close the lid.

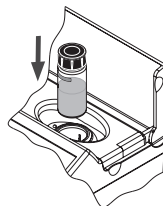
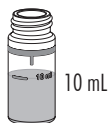

- Press the **Zero** key. The display will show “-0.0-” when the meter is zeroed and ready for measurement.

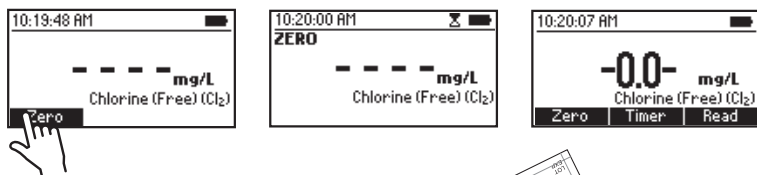

- Remove the cuvette.

POWDER REAGENT PROCEDURE

- Add the content of one packet of **HI93701-0** Free Chlorine Reagent. Replace the cap and shake gently for 20 seconds.

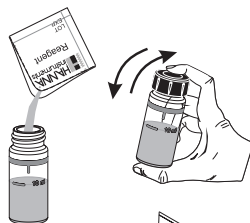

- Reinsert the cuvette into the instrument and close the lid.

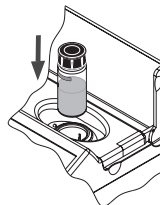

- Press **Timer** and the display will show the countdown prior to the measurement or alternatively, wait for 1 minute and press **Read**. When the timer ends the meter will perform the reading. The instrument displays the results in **mg/L of chlorine (Cl₂)**.

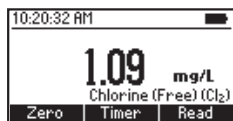

LIQUID REAGENT PROCEDURE

- To an empty cuvette add 3 drops of **HI93701A-F** Free Chlorine Reagent A and 3 drops of **HI93701B-F** Free Chlorine Reagent B.

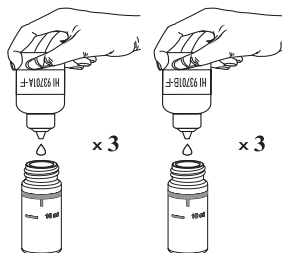

- Swirl gently to mix.



- Add 10 mL of unreacted sample (up to the mark). Replace the cap and shake gently.



- Insert the cuvette into the instrument and close the lid.

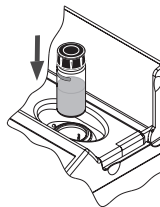

- Press **Read** to start the reading. The instrument displays the results in **mg/L of chlorine (Cl₂)**.

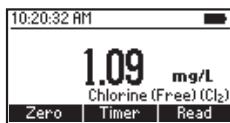
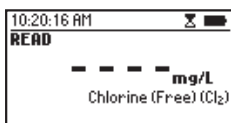
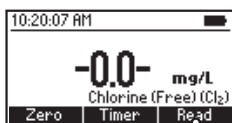

Note: Free and Total Chlorine have to be measured separately with fresh sample following the related procedure if both values are desired.

INTERFERENCES

Interference may be caused by: Bromine, Iodine, Ozone, Oxidized forms of Chromium and Manganese. In case of water with hardness greater than 500 mg/L CaCO₃, shake the sample for approximately 2 minutes after adding the powder reagent.

If the water used for this procedure has an alkalinity value greater than 250 mg/L CaCO₃ or acidity value greater than 150 mg/L CaCO₃, the color of the sample may develop only partially, or may rapidly fade. To resolve this, neutralize the sample with diluted HCl or NaOH.

8.13. CHLORINE, FREE ULTRA LOW RANGE

SPECIFICATIONS

| | |
|--------------|---|
| Range | 0.000 to 0.500 mg/L (as Cl ₂) |
| Resolution | 0.001 mg/L |
| Accuracy | ±0.020 mg/L ±3% of reading at 25 °C |
| Light Source | LED with narrow band interference filter @ 525 nm |
| Method | Adaptation of the Standard Method 4500-Cl G. |

REQUIRED REAGENTS

| Code | Description | Quantity |
|-----------|---------------------------------------|----------|
| HI95762-0 | Free Chlorine Ultra Low Range Reagent | 1 packet |

REAGENTS SETS

| | |
|------------|------------------------|
| HI95762-01 | Reagents for 100 tests |
| HI95762-03 | Reagents for 300 tests |

For other accessories see page 200.

MEASUREMENT PROCEDURE

- Select the **Chlorine Free ULR** method using the procedure described in the Method Selection section (see page 18).
- Fill the cuvette with 10 mL of unreacted sample (up to the mark) and replace the cap.
- Place the cuvette into the holder and close the lid.
- Press the **Zero** key. The display will show “-0.0-” when the meter is zeroed and ready for measurement.



10 mL

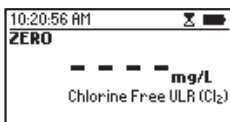
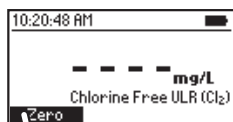
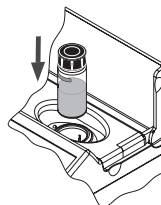

- Remove the cuvette.

- Add one packet of **HI95762-0** Free Chlorine Reagent. Replace the cap and shake gently for 20 seconds.

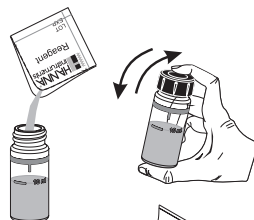

- Reinsert the cuvette into the instrument and close the lid.

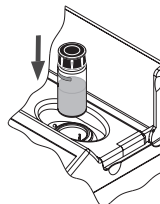

- Press **Timer** and the display will show the countdown prior to the measurement or, alternatively, wait for 1 minute and press **Read**. When the timer ends the meter will perform the reading. The instrument displays the results in **mg/L of chlorine (Cl₂)**.

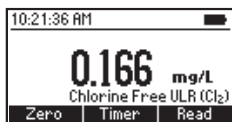
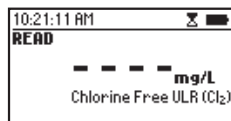

INTERFERENCES

Interference may be caused by:

Alkalinity: above 1,000 mg/L CaCO₃ if present as bicarbonate (HCO₃⁻, sample pH < 8.3); above 25 mg/L CaCO₃ if present as carbonate (CO₃²⁻, sample pH > 9.0). In both cases, it will not reliably develop the full amount of color or it may rapidly fade (negative error). To resolve this, neutralize the sample with diluted HCl.

Acidity: above 150 mg/L CaCO₃. May not reliably develop the full amount of color or it may rapidly fade (negative error). To resolve this, neutralize the sample with diluted NaOH.

Hardness: in case of water with hardness greater than 500 mg/L CaCO₃, shake the sample for approximately 2 minutes after adding the powder reagent.

Bromine (Br₂), Chloride dioxide (ClO₂), Iodine (I₂), Oxidized Manganese and Chromium, Ozone (O₃): positive error.

8.14. CHLORINE, TOTAL

SPECIFICATIONS

| | |
|--------------|---|
| Range | 0.00 to 5.00 mg/L (as Cl ₂) |
| Resolution | 0.01 mg/L |
| Accuracy | ±0.03 mg/L ± 3% of reading at 25 °C |
| Light Source | LED with narrow band interference filter @ 525 nm |
| Method | Adaptation of the EPA DPD method 330.5. |

REQUIRED REAGENTS

POWDER:

| Code | Description | Quantity |
|-----------|------------------------|----------|
| HI93711-0 | Total Chlorine Reagent | 1 packet |

LIQUID:

| Code | Description | Quantity |
|------------|--------------------------|----------|
| HI93701A-T | Total Chlorine Reagent A | 3 drops |
| HI93701B-T | Total Chlorine Reagent B | 3 drops |
| HI93701C-T | Total Chlorine Reagent C | 1 drop |

REAGENT SETS

| | |
|------------|---------------------------------------|
| HI93701-T | Reagents for 300 tests (liquid) |
| HI93711-01 | Reagents for 100 total tests (powder) |
| HI93711-03 | Reagents for 300 total tests (powder) |

For other accessories see page 200.

MEASUREMENT PROCEDURE

- Select the **Chlorine (Total)** method using the procedure described in the Method Selection section (see page 18).
- Fill the cuvette with 10 mL of unreacted sample (up to the mark) and replace the cap.
- Place the cuvette into the holder and close the lid.

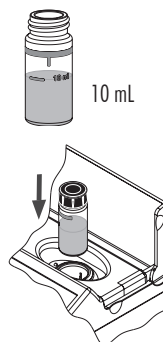

- Press the **Zero** key. The display will show “-0.0-” when the meter is zeroed and ready for measurement.

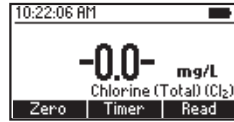
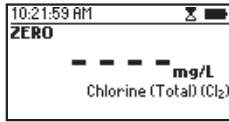
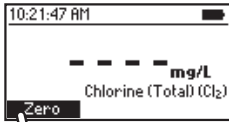

- Remove the cuvette.

POWDER REAGENT PROCEDURE

- Add 1 packet of **HI93711-0** Total Chlorine Reagent. Replace the cap and shake gently for 20 seconds.
- Reinsert the cuvette into the instrument and close the lid.

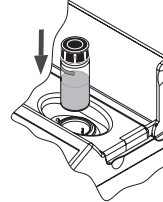
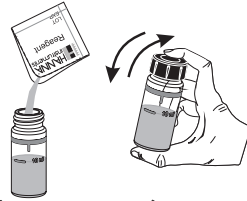

- Press **Timer** and the display will show the countdown prior to the measurement or, alternatively, wait for 2 minutes and 30 seconds and press **Read**. When the timer ends the meter will perform the reading. The instrument displays the results in **mg/L of chlorine (Cl₂)**.

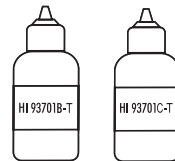
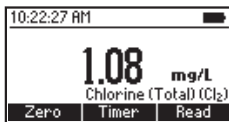
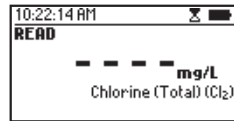

LIQUID REAGENT PROCEDURE

- To an empty cuvette add 3 drops of **HI93701A-T** Total Chlorine Reagent A, 3 drops of **HI93701B-T** Total Chlorine Reagent B, and 1 drop of **HI93701C-T** Total Chlorine Reagent C. Swirl gently to mix.

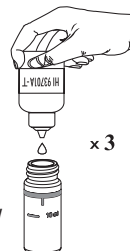

- Add 10 mL of unreacted sample (up to the mark). Replace the cap and shake gently.



- Insert the cuvette into the instrument and close the lid.

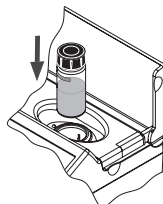

- Press **Timer** and the display will show the countdown prior to the measurement or, alternatively, wait for 2 minutes and 30 seconds and press **Read**. When the timer ends the meter will perform the reading. The instrument displays the results in **mg/L of chlorine (Cl₂)**.

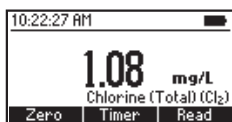
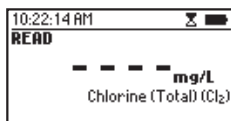
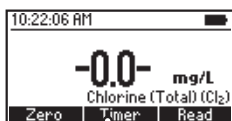

Note: Free and Total Chlorine have to be measured separately with fresh unreacted samples following the related procedure if both values are desired.

INTERFERENCES

Interference may be caused by: Bromine, Iodine, Ozone, Oxidized forms of Chromium and Manganese. In case of water with hardness greater than 500 mg/L CaCO₃ shake the sample for approximately 2 minutes after adding the powder reagent.

If the water used for this procedure has an alkalinity value greater than 250 mg/L CaCO₃ or acidity value greater than 150 mg/L CaCO₃, the color of the sample may develop only partially, or may rapidly fade. To resolve this, neutralize the sample with diluted HCl or NaOH.

8.15. CHLORINE, TOTAL ULTRA LOW RANGE

SPECIFICATIONS

| | |
|--------------|---|
| Range | 0.000 to 0.500 mg/L (as Cl ₂) |
| Resolution | 0.001 mg/L |
| Accuracy | ±0.020 mg/L ±3% of reading at 25 °C |
| Light Source | LED with narrow band interference filter @ 525 nm |
| Method | Adaptation of the EPA recommended Method 330.5. |

REQUIRED REAGENTS

| Code | Description | Quantity |
|-----------|--|----------|
| HI95761-0 | Total Chlorine Ultra Low Range Reagent | 1 packet |

REAGENT SETS

| | |
|------------|------------------------|
| HI95761-01 | Reagents for 100 tests |
| HI95761-03 | Reagents for 300 tests |

For other accessories see page 200.

MEASUREMENT PROCEDURE

- Select the **Chlorine (Total) ULR** method using the procedure described in the Method Selection section (see page 18).

- Fill the cuvette with 10 mL of unreacted sample (up to the mark) and replace the cap.

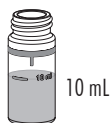

- Place the cuvette into the holder and close the lid.

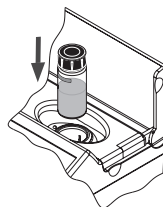

- Press the **Zero** key. The display will show “-0.0-” when the meter is zeroed and ready for measurement.

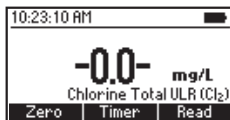
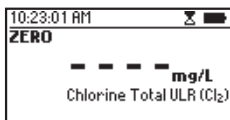
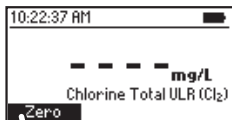

- Remove the cuvette.

- Add one packet of HI95761-0 Total Chlorine Reagent. Replace the cap and shake gently for 20 seconds.

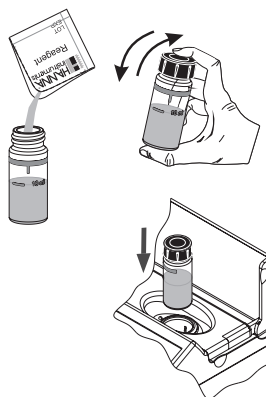

- Reinsert the cuvette into the instrument and close the lid.
- Press **Timer** and the display will show the countdown prior to the measurement or, alternatively, wait for 2 minutes and 30 seconds and press **Read**. When the timer ends the meter will perform the reading. The instrument displays the results in **mg/L of chlorine (Cl₂)**.

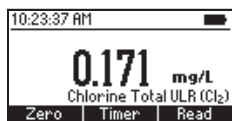
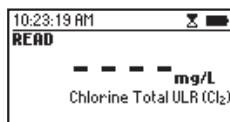
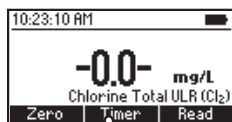

INTERFERENCES

Interference may be caused by:

Alkalinity: above 1,000 mg/L CaCO₃ if present as bicarbonate (HCO₃⁻, sample pH < 8.3); above 25 mg/L CaCO₃ if present as carbonate (CO₃²⁻, sample pH > 9.0). In both cases, it will not reliably develop the full amount of color or it may rapidly fade (negative error). To resolve this, neutralize the sample with diluted HCl.

Acidity: above 150 mg/L CaCO₃. May not reliably develop the full amount of color or it may rapidly fade (negative error). To resolve this, neutralize the sample with diluted NaOH.

Hardness: in case of water with hardness greater than 500 mg/L CaCO₃, shake the sample for approximately 2 minutes after adding the powder reagent.

Bromine (Br₂), Ozone (O₃) and Chlorine dioxide (ClO₂): positive error.

8.16. CHLORINE, TOTAL ULTRA HIGH RANGE

SPECIFICATIONS

| | |
|--------------|--|
| Range | 0 to 500 mg/L (as Cl ₂) |
| Resolution | 1 mg/L |
| Accuracy | ± 3 mg/L ± 3% of reading at 25 °C |
| Light Source | LED lamp with narrow band interference filter @ 525 nm |
| Method | Adaptation of the Standard Methods for Examination of Water and Wastewater, 20th edition, 4500-Cl. |

REQUIRED REAGENTS

| Code | Description | Quantity |
|------------|---|----------|
| HI95771A-0 | Total Chlorine Ultra High Range Reagent A | 1 packet |
| HI95771B-0 | Total Chlorine Ultra High Range Reagent B | 1 packet |

REAGENTS SETS

| | |
|------------|------------------------|
| HI95771-01 | Reagents for 100 tests |
| HI95771-03 | Reagents for 300 tests |

For other accessories see page 200.

MEASUREMENT PROCEDURE

- Select the **Chlorine (Total) UHR** method using the procedure described in the Method Selection section (see page 18).
- Fill the cuvette with 10 mL of unreacted sample (up to the mark) and replace the cap.
- Place the cuvette into the holder and close the lid.
- Press the **Zero** key. The display will show “-0.0-” when the meter is zeroed and ready for measurement.

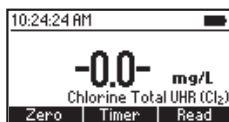
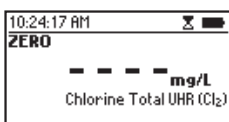
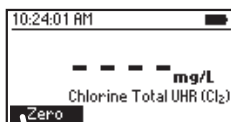
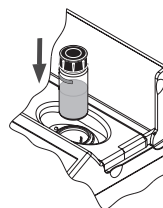

- Remove the cuvette.

- Add one packet of **HI95771A-0** Total Chlorine Ultra High Range Reagent A and one packet **HI95771B-0** Total Chlorine Ultra High Range Reagent B. Replace the cap and shake gently for 20 seconds.



- Reinsert the cuvette into the instrument and close the lid.

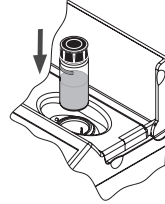

- Press **Timer** and the display will show the countdown prior to the measurement or, alternatively, wait for 1 minute and press **Read**. When the timer ends the meter will perform the reading. The instrument displays the results in **mg/L of chlorine (Cl₂)**.

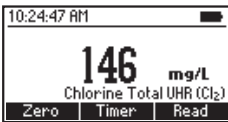
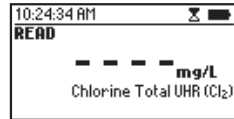
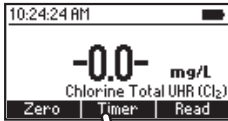

INTERFERENCES

Interference may be caused by:

Bromine (Br₂), Oxidized Manganese, Chromium, Chlorine Dioxide (ClO₂), Ozone (O₃) and Iodine (I₂).

8.17. CHROMIUM (VI) LOW RANGE

SPECIFICATIONS

| | |
|--------------|---|
| Range | 0 to 300 $\mu\text{g/L}$ (as Cr (VI)) |
| Resolution | 1 $\mu\text{g/L}$ |
| Accuracy | $\pm 10 \mu\text{g/L} \pm 4\%$ of reading at 25 °C |
| Light Source | LED with narrow band interference filter @ 525 nm |
| Method | Adaptation of the ASTM Manual of Water and Environmental Technology, D1687 Diphenylcarbohydrazide method. |

REQUIRED REAGENTS

| Code | Description | Quantity |
|-----------|---------------------------------|----------|
| HI93749-0 | Chromium (VI) Low Range Reagent | 1 packet |

REAGENT SETS

| | |
|------------|------------------------|
| HI93749-01 | Reagents for 100 tests |
| HI93749-03 | Reagents for 300 tests |

For other accessories see page 200.

MEASUREMENT PROCEDURE

- Select the **Chromium (VI) LR** method using the procedure described in the Method Selection section (see page 18).
- Fill the cuvette with 10 mL of unreacted sample (up to the mark) and replace the cap.
- Place the cuvette into the holder and close the lid.
- Press the **Zero** key. The display will show “-0.0-” when the meter is zeroed and ready for measurement.

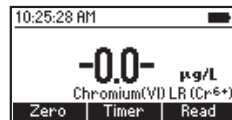
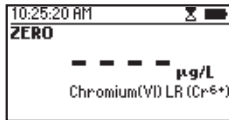
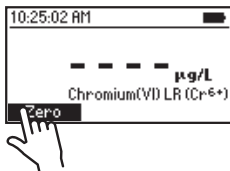
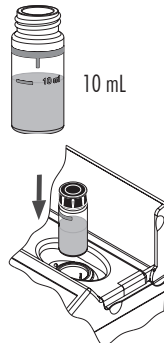

- Remove the cuvette.
- Add one packet of **HI93749-0** Chromium(VI) Low Range Reagent. Replace the cap and shake vigorously for about 10 seconds.

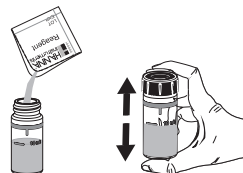

- Reinsert the cuvette into the instrument and close the lid.

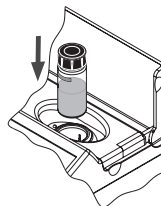

- Press **Timer** and the display will show the countdown prior to the measurement or, alternatively, wait for 6 minutes and press **Read**. When the timer ends the meter will perform the reading. The instrument displays concentration in $\mu\text{g/L}$ of chromium (Cr^{6+}).

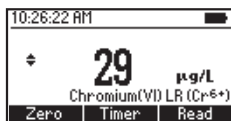
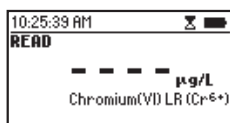
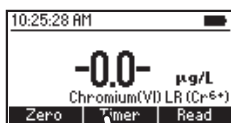

- Press **▲** or **▼** to access the second level functions.
- Press the **Chem Frm** key to convert the result to $\mu\text{g/L}$ of chromate (CrO_4^{2-}) and dichromate ($\text{Cr}_2\text{O}_7^{2-}$).

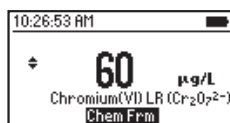
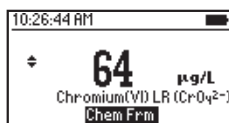
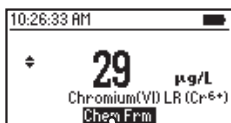

- Press **▲** or **▼** to return to the measurement screen.

INTERFERENCES

Interference may be caused by: Vanadium above 1 ppm. However, waiting 10 minutes before reading removes the interference. Iron above 1 ppm. Mercurous and mercuric ions cause slight inhibition of the reaction.

8.18. CHROMIUM (VI) HIGH RANGE

SPECIFICATIONS

| | |
|--------------|--|
| Range | 0 to 1000 $\mu\text{g/L}$ (as Cr(VI)) |
| Resolution | 1 $\mu\text{g/L}$ |
| Accuracy | $\pm 5 \mu\text{g/L} \pm 4\%$ of reading at 25 °C |
| Light Source | LED with narrow band interference filter @ 525 nm |
| Method | Adaptation of the ASTM Manual of Water and Environmental Technology, D1687, Diphenylcarbohydrazide method. |

REQUIRED REAGENTS

| Code | Description | Quantity |
|-----------|---------------------------------|----------|
| HI93723-0 | Chromium(VI) High Range Reagent | 1 packet |

REAGENT SETS

HI93723-01 Reagents for 100 tests

HI93723-03 Reagents for 300 tests

For other accessories see page 200.

MEASUREMENT PROCEDURE

- Select the **Chromium(VI) HR** method using the procedure described in the Method Selection section (see page 18).
- Fill the cuvette with 10 mL of unreacted sample (up to the mark) and replace the cap.
- Place the cuvette into the holder and close the lid.
- Press the **Zero** key. The display will show “-0.0-” when the meter is zeroed and ready for measurement.

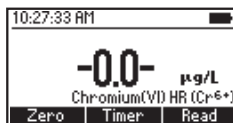
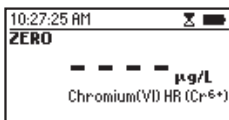
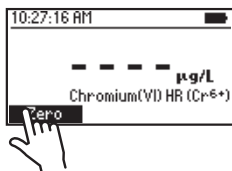
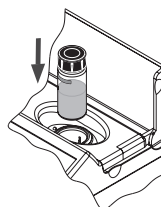

- Remove the cuvette.
- Add one packet of **HI93723-0** Chromium(VI) High Range Reagent. Replace the cap and shake vigorously for about 10 seconds.

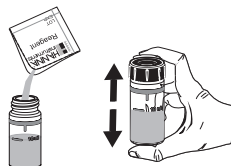

- Reinsert the cuvette into the instrument and close the lid.

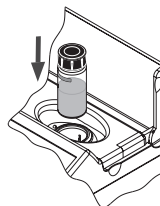

- Press **Timer** and the display will show the countdown prior to the measurement or, alternatively, wait for 6 minutes and press **Read**. When the timer ends the meter will perform the reading. The instrument displays concentration in $\mu\text{g/L}$ of chromium (Cr^{6+}).

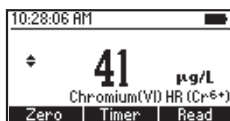
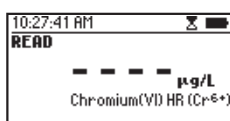
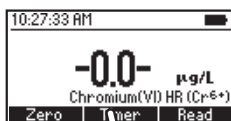

- Press \blacktriangle or \blacktriangledown to access the second level functions.
- Press the **Chem Frm** key to convert the result to $\mu\text{g/L}$ of chromate (CrO_4^{2-}) and dichromate ($\text{Cr}_2\text{O}_7^{2-}$).

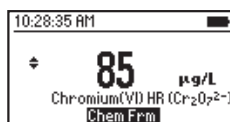
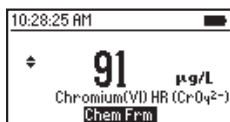
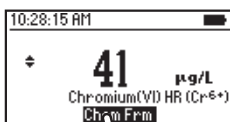

- Press \blacktriangle or \blacktriangledown to return to the measurement screen.

INTERFERENCES

Interference may be caused by:

Vanadium above 1 ppm. However, waiting 10 minutes before reading removes the interference.

Iron above 1 ppm.

Mercurous and mercuric ions cause slight inhibition of the reaction.

8.19. COLOR OF WATER

SPECIFICATIONS

| | |
|--------------|--|
| Range | 0 to 500 PCU (Platinum Cobalt Units) |
| Resolution | 1 PCU |
| Accuracy | ± 10 PCU $\pm 5\%$ of reading at 25 °C |
| Light Source | LED with narrow band interference filter @ 420 nm |
| Method | Adaptation of the Standard Methods for the Examination of Water and Wastewater, 18th edition, Colorimetric Platinum Cobalt method. |

REQUIRED ACCESSORIES

0.45 μ m membrane for true color measurement.
 For other accessories see page 200.

MEASUREMENT PROCEDURE

- Select the **Color of Water** method using the procedure described in the Method Selection section (see page 18).
- Fill the first cuvette (#1) up to the mark with deionized water and replace the cap.
- Place the blank (#1) into the holder and close the lid.

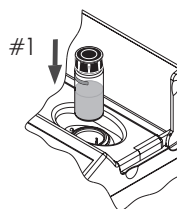
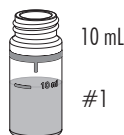

- Press the **Zero** key. The display will show “-0.0-” when the meter is zeroed and ready for measurement.

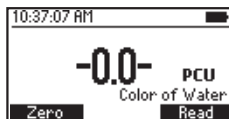
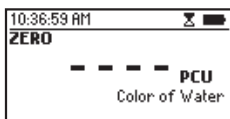
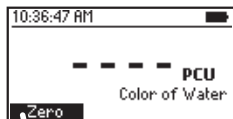

- Remove the cuvette

- Fill the second cuvette (#2) up to the mark with unfiltered sample and replace the cap. This is the apparent color.

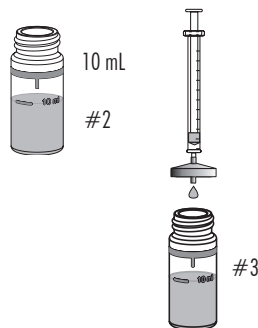

- Filter 10 mL of sample through a filter with a 0.45 μm membrane into the third cuvette (#3), up to the 10 mL mark and replace the cap. This is the true color.

- Insert the apparent color cuvette (#2) into the instrument and close the lid.

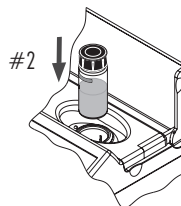

- Press **Read** to start the reading. The meter displays the value of apparent color in **Platinum Cobalt Units (PCU)**.

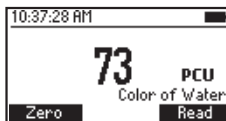
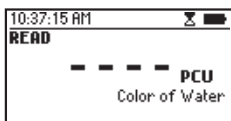
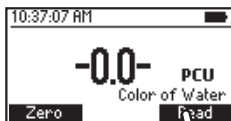

- Remove the apparent color cuvette (#2) from the instrument, insert the true color cuvette (#3) into the instrument and close the lid.

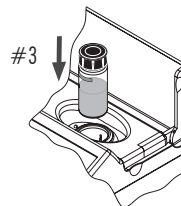

- Press **Read** to start the reading. The meter displays the true color in **Platinum Cobalt Units (PCU)**.

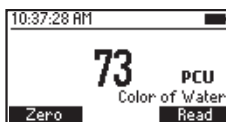
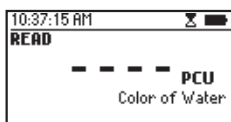
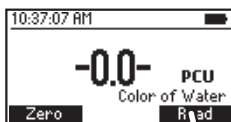

8.20. COPPER LOW RANGE

SPECIFICATIONS

| | |
|--------------|---|
| Range | 0.000 to 1.500 mg/L (as Cu) |
| Resolution | 0.001 mg/L |
| Accuracy | ±0.010 mg/L ± 5% of reading at 25 °C |
| Light Source | LED with narrow band interference filter @ 575 nm |
| Method | Adaptation of the EPA method. |

REQUIRED REAGENTS

| Code | Description | Quantity |
|-----------|--------------------------|----------|
| HI95747-0 | Copper Low Range Reagent | 1 packet |

REAGENT SETS

HI95747-01 Reagents for 100 tests

HI95747-03 Reagents for 300 tests

For other accessories see page 200.

MEASUREMENT PROCEDURE

- Select the **Copper LR** method using the procedure described in the Method Selection section (see page 18).
- Fill the cuvette with 10 mL of unreacted sample (up to the mark) and replace the cap.



- Place the cuvette into the holder and close the lid.

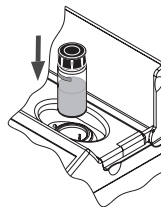

- Press the **Zero** key. The display will show “-0.0-” when the meter is zeroed and ready for measurement.

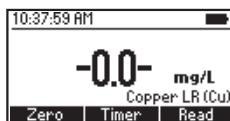
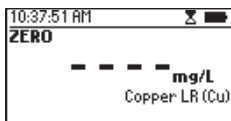
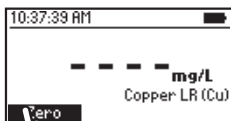

- Remove the cuvette.
- Add one packet of HI95747-0 Copper Low Range Reagent. Replace the cap and shake gently for about 15 seconds.

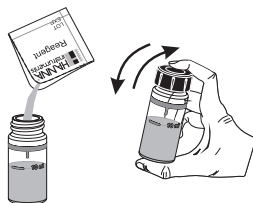

- Reinsert the cuvette into the instrument and close the lid.

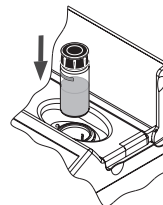

- Press **Timer** and the display will show the countdown prior to the measurement or, alternatively, wait for 45 seconds and press **Read**. When the timer ends the meter will perform the reading. The instrument displays the results in **mg/L of copper (Cu)**.

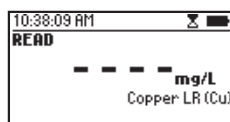
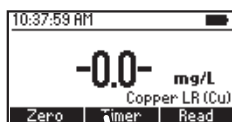

INTERFERENCES

Interference may be caused by:

Silver, Cyanide.

For samples overcoming buffering capacity of reagent (around pH 6.8), pH should be adjusted between 6 and 8.

8.21. COPPER HIGH RANGE

SPECIFICATIONS

| | |
|--------------|---|
| Range | 0.00 to 5.00 mg/L (as Cu) |
| Resolution | 0.01 mg/L |
| Accuracy | ±0.02 mg/L ±4% of reading at 25 °C |
| Light Source | LED with narrow band interference filter @ 575 nm |
| Method | Adaptation of the EPA method. |

REQUIRED REAGENTS

| Code | Description | Quantity |
|-----------|---------------------------|----------|
| HI93702-0 | Copper High Range Reagent | 1 packet |

REAGENT SETS

HI93702-01 Reagents for 100 tests

HI93702-03 Reagents for 300 tests

For other accessories see page 200.

MEASUREMENT PROCEDURE

- Select the **Copper HR** method using the procedure described in the Method Selection section (see page 18).

- Fill the cuvette with 10 mL of unreacted sample (up to the mark) and replace the cap.



- Place the cuvette into the holder and close the lid.

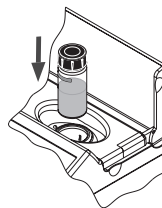

- Press the **Zero** key. The display will show “-0.0-” when the meter is zeroed and ready for measurement.

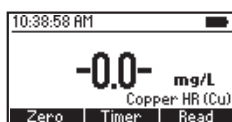
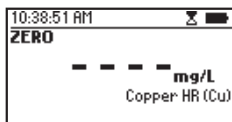
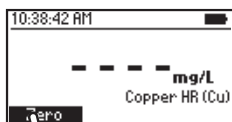

- Remove the cuvette.
- Add one packet of HI93702-0 Copper High Range Reagent. Replace the cap and shake gently for about 15 seconds.

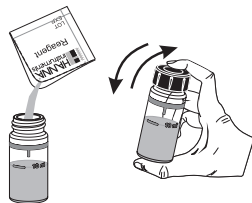

- Reinsert the cuvette into the instrument and close the lid.

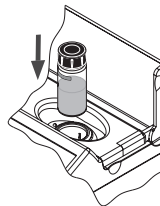

- Press **Timer** and the display will show the countdown prior to the measurement or, alternatively, wait for 45 seconds and press **Read**. When the timer ends the meter will perform the reading. The instrument displays the results in **mg/L of copper (Cu)**.

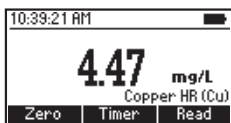
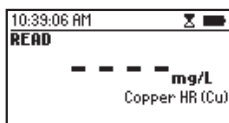
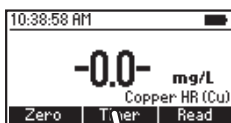

INTERFERENCES

Interference may be caused by:
Silver, Cyanide.

For samples overcoming buffering capacity of reagent (around pH 6.8), pH should be adjusted between 6 and 8.

8.22. CYANURIC ACID

SPECIFICATIONS

| | |
|--------------|---|
| Range | 0 to 80 mg/L (as CYA) |
| Resolution | 1 mg/L |
| Accuracy | ± 1 mg/L $\pm 15\%$ of reading at 25 °C |
| Light Source | LED with narrow band interference filter @ 525 nm |
| Method | Adaptation of the turbidimetric method. |

REQUIRED REAGENTS

| Code | Description | Quantity |
|-----------|-----------------------|----------|
| HI93722-0 | Cyanuric Acid Reagent | 1 packet |

REAGENT SETS

| | |
|------------|------------------------|
| HI93722-01 | Reagents for 100 tests |
| HI93722-03 | Reagents for 300 tests |

For other accessories see page 200.

MEASUREMENT PROCEDURE

- Select the [Cyanuric Acid](#) method using the procedure described in the Method Selection section (see page 18).

- Fill the first cuvette with 10 mL of unreacted sample (up to the mark) and replace the cap.

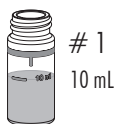

- Place the cuvette into the holder and close the lid.

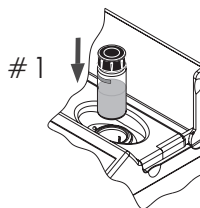

- Press the **Zero** key. The display will show “-0.0-” when the meter is zeroed and ready for measurement.

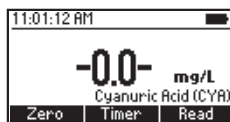
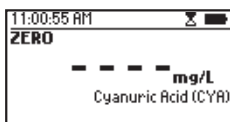
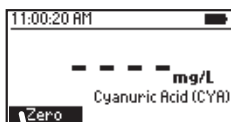

- Fill a beaker with 25 mL sample (up to the mark).
- Add one packet of **HI93722-0** Cyanuric Acid Reagent and mix to dissolve.



- Fill a second cuvette with 10 mL of the reacted sample, up to the mark, and replace the cap.



- Reinsert the cuvette into the instrument and close the lid.

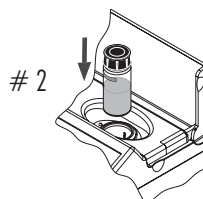

- Press **Timer** and the display will show the countdown prior to the measurement or, alternatively, wait for 45 seconds and press **Read**. When the timer ends the meter will perform the reading. The instrument displays the concentration in **mg/L of cyanuric acid**.

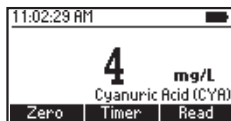
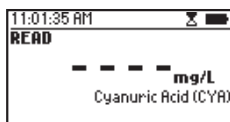
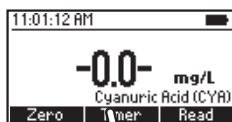

8.23. FLUORIDE LOW RANGE

SPECIFICATIONS

| | |
|--------------|--|
| Range | 0.00 to 2.00 mg/L (as F ⁻) |
| Resolution | 0.01 mg/L |
| Accuracy | ±0.03 mg/L ±3% of reading at 25 °C |
| Light Source | LED with narrow band interference filter @ 575 nm |
| Method | Adaptation of the Standard Methods for the Examination of Water and Wastewater, 18th edition, SPADNS method. |

REQUIRED REAGENT

| Code | Description | Quantity |
|-----------|----------------------------|----------|
| HI93729-0 | Fluoride Low Range Reagent | 4 mL |

REAGENT SETS

HI93729-01 Reagents for 100 tests

HI93729-03 Reagents for 300 tests

For other accessories see page 200.

MEASUREMENT PROCEDURE

- Select the **Fluoride LR** method using the procedure described in the Method Selection section (see page 18).
- Add 2 mL of **HI93729-0** Fluoride Low Range Reagent to two cuvettes.
- Use a plastic pipette to fill the cuvette to the 10 mL mark with deionized water (#1), replace the cap and invert several times to mix.

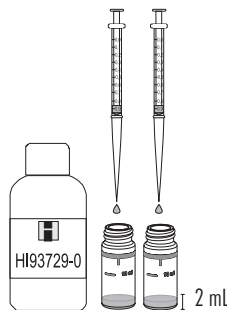

- Use a plastic pipette to fill the second cuvette to the 10 mL mark with unreacted sample (#2), replace the cap and invert several times to mix.

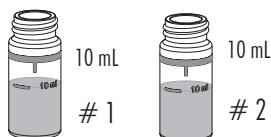

- Place the first cuvette (#1) into the holder and close the lid.

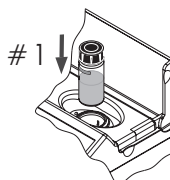

- Press **Timer** and the display will show the countdown prior to zeroing the blank or, alternatively, wait for two minutes and press **Zero**. The display will show “-0.0-” when the meter is zeroed and ready for measurement.

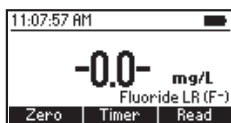
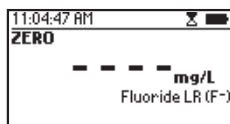
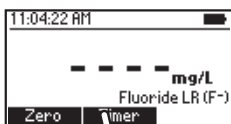

- Remove the cuvette.
- Insert the second cuvette (#2) with the reacted sample into the instrument and close the lid.
- Press **Read** to start reading. The instrument displays the results in **mg/L of fluoride (F-)**.

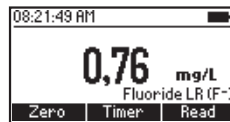
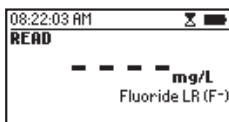
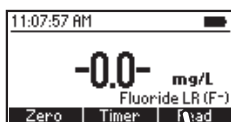
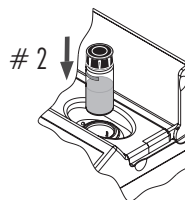

Note: For wastewater or seawater samples, before performing measurements, distillation is required. For most accurate results use two graduated pipettes to deliver exactly 8 mL of deionized water and 8 mL of sample.

INTERFERENCES

Interferences may be caused by:

Alkalinity (as CaCO₃) above 5000 mg/L

Aluminum above 0.1 mg/L

Iron, ferric above 10 mg/L

Chloride above 700 mg/L

ortho-Phosphate above 16 mg/L

Sodium hexametaphosphate above 1.0 mg/L

Sulfate above 200 mg/L

Highly colored and turbid samples may require distillation

Highly alkaline samples can be neutralized with nitric acid.

8.24. FLUORIDE HIGH RANGE

SPECIFICATIONS

| | |
|--------------|--|
| Range | 0.0 to 20.0 mg/L (as F) |
| Resolution | 0.1 mg/L |
| Accuracy | ± 0.5 mg/L $\pm 3\%$ of reading at 25 °C |
| Light Source | LED with narrow band interference filter @ 575 nm |
| Method | Adaptation of the Standard Methods for the Examination of Water and Wastewater, 18 th edition, SPADNS method. |

REQUIRED REAGENT

| Code | Description | Quantity |
|------------|-------------------------------|----------|
| HI93739A-0 | Fluoride High Range Reagent A | 2 mL |
| HI93739B-0 | Fluoride High Range Reagent B | 8 mL |

REAGENT SETS

| | |
|------------|------------------------|
| HI93739-01 | Reagents for 100 tests |
| HI93739-03 | Reagents for 300 tests |

For other accessories see page 200.

MEASUREMENT PROCEDURE

- Select the **Fluoride HR** method using the procedure described in the Method Selection section (see page 18).
- Add 2.00 mL of **HI93739A-0** Fluoride High Range Reagent A to the cuvette and use the pipette to fill up the cuvette to the 10 mL mark with **HI93739B-0** Fluoride High Range Reagent B.

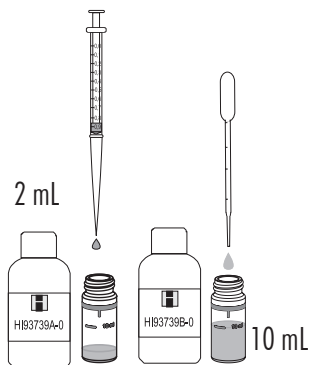

- Replace the cap and invert several times to mix.
- Place the cuvette into the holder and close the lid.

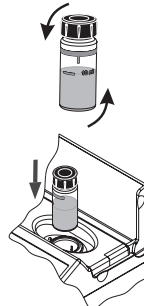

- Press **Timer** and the display will show the countdown prior to zeroing the blank or, alternatively, wait for one minute and press **Zero**. The display will show “-0.0-” when the meter is zeroed and ready for measurement.

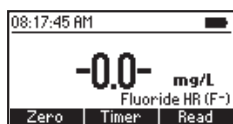
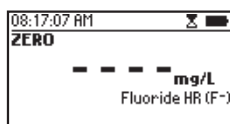
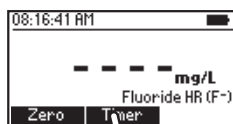

- Remove the cuvette.
- Add 1 mL of sample to the cuvette using the second 1 mL syringe.
- Replace the cap and invert several times to mix.



- Insert the cuvette into the instrument and close the lid.

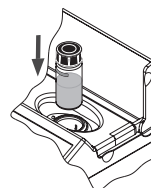

- Press **Timer** and the display will show the countdown prior to the measurement or, alternatively, wait for one minute and press **Read**. When the timer ends the meter will perform the reading. The instrument displays the results in **mg/L of fluoride (F⁻)**.

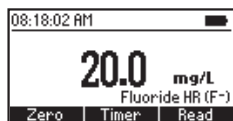
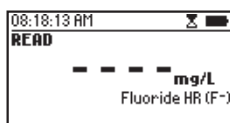
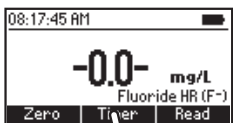

Note: For wastewater or seawater samples, before performing measurements, distillation is required.

INTERFERENCES

Interferences may be caused by:

Alkalinity (as CaCO_3) above 5000 mg/L

Aluminum above 0.1 mg/L

Iron, ferric above 10 mg/L

Chloride above 700 mg/L

ortho-Phosphate above 16 mg/L

Sodium hexametaphosphate above 1.0 mg/L

Sulfate above 200 mg/L

Highly colored and turbid samples may require distillation

Highly alkaline samples can be neutralized with nitric acid.

8.25. HARDNESS, CALCIUM

SPECIFICATIONS

| | |
|--------------|---|
| Range | 0.00 to 2.70 mg/L (as CaCO ₃) |
| Resolution | 0.01 mg/L |
| Accuracy | ±0.11 mg/L ±5% of reading at 25 °C |
| Light Source | LED with narrow band interference filter @ 525 nm |
| Method | Adaptation of the Standard Methods for the Examination of Water and Wastewater, 18th edition, Calmagite method. |

REQUIRED REAGENTS

| Code | Description | Quantity |
|------------|----------------------------|----------|
| HI93720A-0 | Calcium Hardness Reagent A | 0.5 mL |
| HI93720B-0 | Calcium Hardness Reagent B | 0.5 mL |
| HI93720C-0 | Calcium Hardness Reagent C | 1 drop |

REAGENT SETS

HI93720-01 Reagents for 100 tests

HI93720-03 Reagents for 300 tests

For other accessories see page 200.

MEASUREMENT PROCEDURE

- Select the **Hardness (Calcium)** method using the procedure described in the Method Selection section (see page 18).
- Rinse a graduated beaker several times with unreacted sample, before filling it to the 50 mL mark with the sample.
- Add 0.5 mL of **HI93720A-0** Calcium Hardness Reagent A and swirl to mix.
- Add 0.5 mL of **HI93720B-0** Calcium Hardness Reagent B and swirl to mix. Use this solution to rinse 2 cuvettes before filling them up to the 10 mL mark.

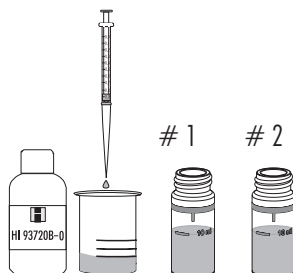
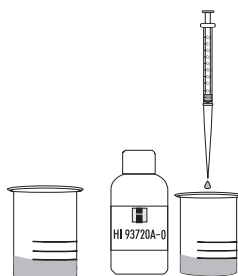

- Add 1 drop of **HI93720C-0** Calcium Hardness Reagent C to one cuvette (#1).



- Replace the cap and invert the cuvette several times to mix. This is the blank.

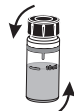

- Place the blank (#1) into the holder and close the lid.

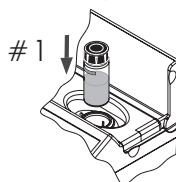

- Press the **Zero** key. The display will show “-0.0-” when the meter is zeroed and ready for measurement.

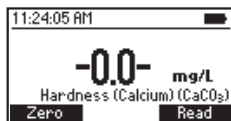
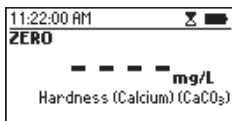
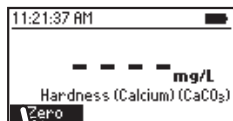

- Remove the blank (#1) and insert the second cuvette (#2) into the instrument.

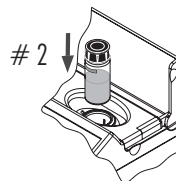

- Press **Read** to start the reading. The instrument displays concentration in **mg/L** of calcium carbonate (CaCO_3).

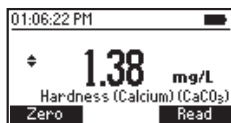
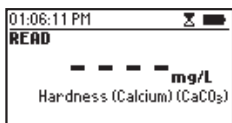
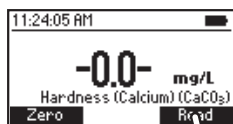

- Press **▲** or **▼** to access the second level functions.

- Press the **Chem Frm** key to convert the results to French degrees (°f), German degrees (°dH), and English degrees (°E).

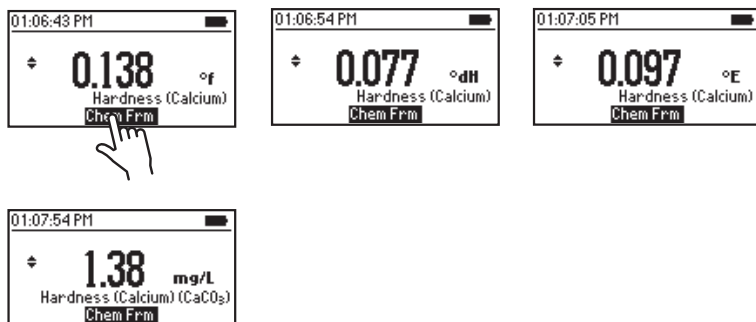

- Press ▲ or ▼ to return to the measurement screen.

Note: This test will detect any calcium contamination in the beaker, measuring syringes or sample cells. To test cleanliness repeat the test multiple times until you obtain consistent results.

SAMPLE DILUTION

This meter is designed to determine low levels of hardness, typically found in water purification systems.

When testing some other sources of water, it is not uncommon to come across levels of hardness that are greater than the range of this meter.

This problem can be overcome through dilution. Dilutions must be performed with hardness-free water or the readings will be erroneous.

A dilution to reduce the level of hardness by a factor of one hundred is performed as follows:

- Fill a 1 mL syringe with the sample.
- Place the syringe in a 50 mL beaker, making sure that the beaker is clean and empty, and inject 0.5 mL into the beaker.
- Fill the beaker up to the 50 mL mark with hardness-free water.

INTERFERENCES

Interference may be caused by excessive amounts of heavy metals.

8.26. HARDNESS, MAGNESIUM

SPECIFICATIONS

| | |
|--------------|---|
| Range | 0.00 to 2.00 mg/L (CaCO ₃) |
| Resolution | 0.01 mg/L |
| Accuracy | ±0.11 mg/L ±5% of reading at 25 °C |
| Light Source | LED with narrow band interference filter @ 525 nm |
| Method | Adaptation of the Standard Methods for the Examination of Water and Wastewater, 18th edition, EDTA Colorimetric method. |

REQUIRED REAGENTS

| Code | Description | Quantity |
|------------|------------------------------|----------|
| HI93719A-0 | Magnesium Hardness Reagent A | 0.5 mL |
| HI93719B-0 | Magnesium Hardness Reagent B | 0.5 mL |
| HI93719C-0 | Magnesium Hardness Reagent C | 1 drop |
| HI93719D-0 | Magnesium Hardness Reagent D | 1 drop |

REAGENT SETS

HI93719-01 Reagents for 100 tests

HI93719-03 Reagents for 300 tests

For other accessories see page 200.

MEASUREMENT PROCEDURE

- Select the **Hardness (Magnesium)** method using the procedure described in the Method Selection section (see page 18).
- Rinse a graduated beaker several times with unreacted sample before filling it to the 50 mL mark with the sample.
- Add 0.5 mL of **HI93719A-0** Magnesium Hardness Reagent A, then swirl to mix.
- Add 0.5 mL of **HI93719B-0** Magnesium Hardness Reagent B and swirl to mix. Use this solution to rinse 2 cuvettes.

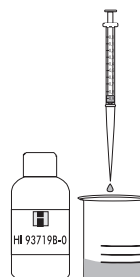
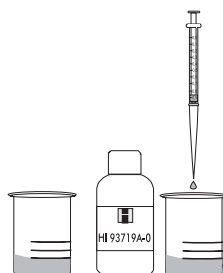

- Fill both cuvettes up to the 10 mL mark.

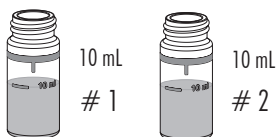

- Add 1 drop of HI93719C-0 Magnesium Hardness Reagent C to one cuvette (#1), replace the cap and invert the cuvette several times to mix. This is the blank.

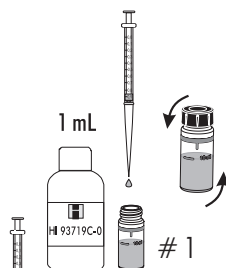

- Add 1 drop of HI93719D-0 Magnesium Hardness Reagent D to the second cuvette (#2), replace the cap and invert the cuvette several times to mix. This is the sample.

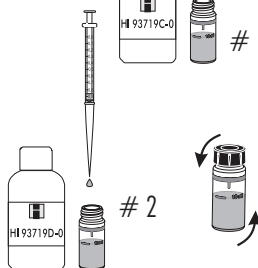

- Place the blank (#1) into the holder and close the lid.

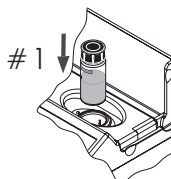

- Press the **Zero** key. The display will show “-0.0-” when the meter is zeroed and ready for measurement.

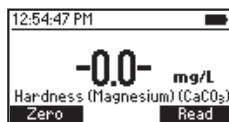
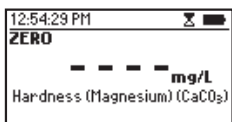
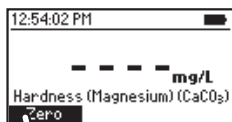

- Remove the blank (#1), insert the sample (#2) into the instrument and close the lid.

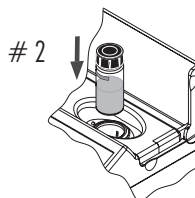

- Press **Read** to start the reading. The instrument displays concentration in mg/L of calcium carbonate. (CaCO_3).

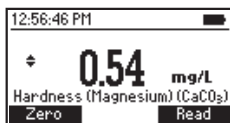
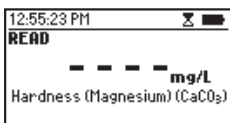
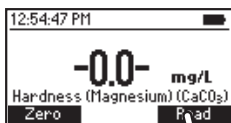

- Press **▲** or **▼** to access the second level functions.
- Press the **Chem Frm** key to convert the results to **French degrees (°f)**, **German degrees (°dH)**, and **English degrees (°E)**.

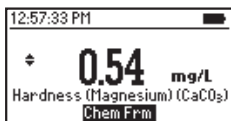
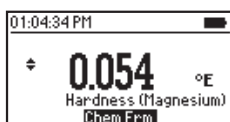
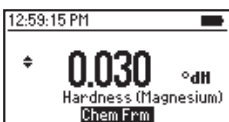

- Press **▲** or **▼** to return to the measurement screen.

Note: This test will detect any magnesium contamination in the beakers, measuring syringes, or sample cells. To test cleanliness repeat the test multiple times until you obtain consistent results.

SAMPLE DILUTION

This meter is designed to determine hardness typically found in water purification systems. In order to measure samples with high hardness, follow dilution procedure explained on page 93.

INTERFERENCES

Interference may be caused by excessive amounts of heavy metals.

8.27. HARDNESS, TOTAL LOW RANGE

SPECIFICATIONS

| | |
|--------------|---|
| Range | 0 to 250 mg/L (as CaCO ₃) |
| Resolution | 1 mg/L |
| Accuracy | ± 5 mg/L ± 4% of reading at 25 °C |
| Light Source | LED with narrow band interference filter @ 466 nm |
| Method | Adaptation of the EPA recommended method 130.1. |

REQUIRED REAGENTS

| Code | Description | Quantity |
|--------------|------------------------------|----------|
| HI93735IND-0 | Hardness Indicator Reagent | 0.5 mL |
| HI93735A-LR | Hardness Low Range Reagent A | 9 mL |
| HI93735B-0 | Hardness Buffer Reagent B | 2 drops |
| HI93735C-0 | Fixing Reagent | 1 packet |

REAGENT SETS

| | |
|------------|---|
| HI93735-00 | Reagents for 100 tests (LR, 0 to 250 mg/L) |
| HI93735-0 | Reagents for 300 tests (LR - 100 tests, MR - 100 tests, HR - 100 tests) |

For other accessories see page 200.

MEASUREMENT PROCEDURE

- Select the **Hardness Total LR** method using the procedure described in the Method Selection section (see page 18).

- Add 0.5 mL of unreacted sample to the cuvette. Add 0.5 mL of **HI93735IND-0** Hardness Indicator Reagent.

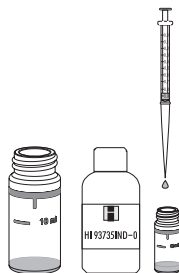

- With the plastic dropper fill the cuvette up to the 10 mL mark with **HI93735A-LR** Hardness Low Range Reagent A.

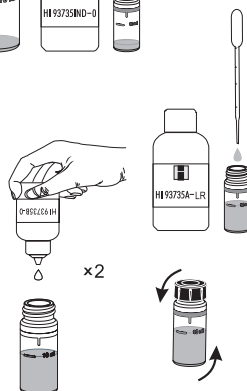

- Add two drops of **HI93735B-0** Hardness Buffer Reagent B. Replace the cap and invert 5 times to mix.

- Place the cuvette into the holder and close the lid.

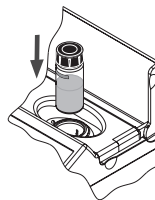

- Press the **Zero** key. The display will show “-0.0-” when the meter is zeroed and ready for measurement.

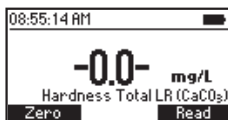
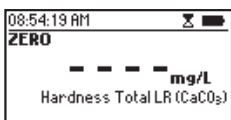
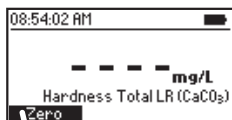

- Remove the cuvette and add the contents of one packet of **HI93735C-0** Fixing Reagent. Replace the cap and shake gently to mix 20 seconds.



- Place the cuvette into the holder and close the lid.

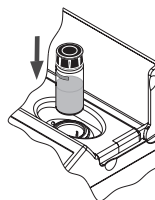

- Press **Read** to start the reading. The instrument displays concentration in **mg/L of calcium carbonate (CaCO₃)**.

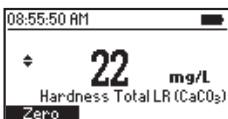
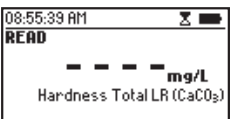
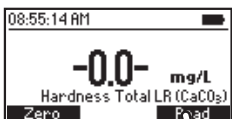

- Press **▲** or **▼** to access the second level functions.

- Press the Chem Frm key to convert the result to French degrees ($^{\circ}\text{f}$), English degrees ($^{\circ}\text{E}$), and German degrees ($^{\circ}\text{dH}$).

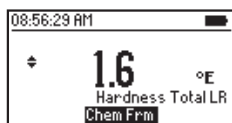
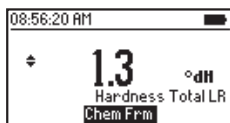
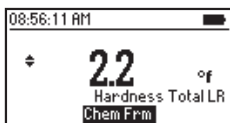
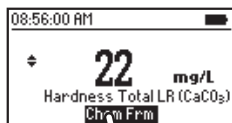

- Press ▲ or ▼ to return to the measurement screen.

INTERFERENCE

Interferences may be caused by excessive amounts of heavy metals.

8.28. HARDNESS, TOTAL MEDIUM RANGE

SPECIFICATIONS

| | |
|--------------|---|
| Range | 200 to 500 mg/L (as CaCO ₃) |
| Resolution | 1 mg/L |
| Accuracy | ±7 mg/L ±3% of reading at 25 °C |
| Light Source | LED with narrow band interference filter @ 466 nm |
| Method | Adaptation of the EPA recommended method 130.1. |

REQUIRED REAGENTS

| Code | Description | Quantity |
|--------------|----------------------------|----------|
| HI93735IND-0 | Hardness Indicator Reagent | 0.5 mL |
| HI93735A-MR | Hardness Medium Reagent A | 9 mL |
| HI93735B-0 | Hardness Buffer Reagent B | 2 drops |
| HI93735C-0 | Fixing Reagent | 1 packet |

REAGENT SETS

| | |
|------------|---|
| HI93735-01 | Reagents for 100 tests (MR, 200 to 500 mg/L) |
| HI93735-0 | Reagents for 300 tests (LR - 100 tests, MR - 100 tests, HR - 100 tests) |

For other accessories see page 200.

MEASUREMENT PROCEDURE

- Select the **Hardness Total MR** method using the procedure described in the Method Selection section (see page 18).

- Add 0.5 mL of unreacted sample to the cuvette.
Add 0.5 mL of **HI93735IND-0** Hardness Indicator Reagent.

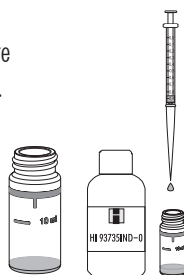

- With the plastic dropper fill the cuvette up to the 10 mL mark with **HI93735A-MR** Hardness Medium Range Reagent A.

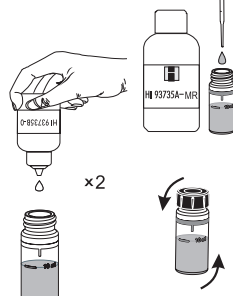

- Add two drops of **HI93735B-0** Hardness Buffer Reagent B. Replace the cap and invert 5 times to mix.

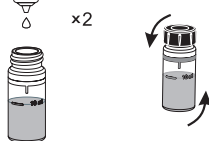

- Place the cuvette into the holder and close the lid.

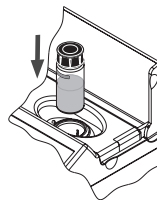

- Press the **Zero** key. The display will show “-0.0-” when the meter is zeroed and ready for measurement.

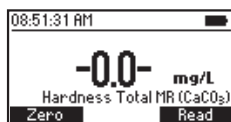
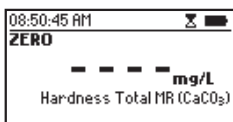
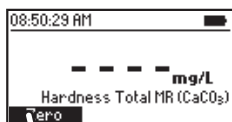

- Remove the cuvette and add one packet of **HI93735C-0** Fixing Reagent. Replace the cap and shake gently to mix 20 seconds.

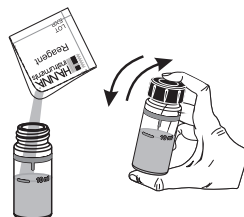

- Place the cuvette into the holder and close the lid.

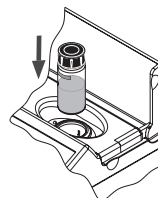

- Press **Read** to start the reading. The instrument displays concentration in **mg/L** of calcium carbonate (CaCO_3).

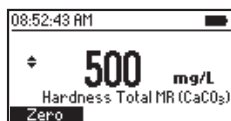
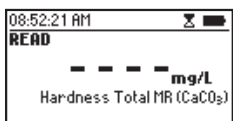
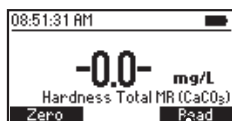

- Press **▲** or **▼** to access the second level functions.

- Press the Chem Frm key to convert the result to French degrees (°f), English degrees (°E) and German degrees (°dH).

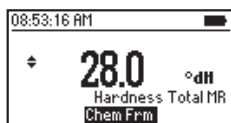
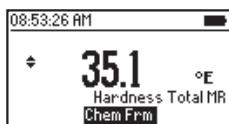
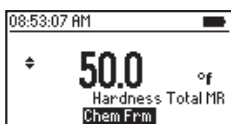
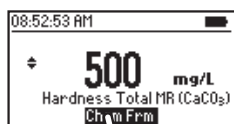

- Press ▲ or ▼ to return to the measurement screen.

INTERFERENCES

Interferences may be caused by excessive amounts of heavy metals.

8.29. HARDNESS, TOTAL HIGH RANGE

SPECIFICATIONS

| | |
|--------------|---|
| Range | 400 to 750 mg/L (as CaCO ₃) |
| Resolution | 1 mg/L |
| Accuracy | ±10 mg/L ±2% of reading at 25 °C |
| Light Source | LED with narrow band interference filter @ 466 nm |
| Method | Adaptation of the EPA recommended method 130.1. |

REQUIRED REAGENTS

| Code | Description | Quantity |
|--------------|-------------------------------|----------|
| HI93735IND-0 | Hardness Indicator Reagent | 0.5 mL |
| HI93735A-HR | Hardness High Range Reagent A | 9 mL |
| HI93735B-0 | Hardness Buffer Reagent B | 2 drops |
| HI93735C-0 | Fixing Reagent | 1 packet |

REAGENT SETS

HI93735-02 Reagents for 100 tests (HR, 400 to 750 mg/L)

HI93735-0 Reagents for 300 tests (LR - 100 tests, MR - 100 tests, HR - 100 tests)

For other accessories see page 200.

MEASUREMENT PROCEDURE

- Select the **Total Hardness HR** method using the procedure described in the Method Selection section (see page 18).

- Add 0.5 mL of unreacted sample to the cuvette. Add 0.5 mL of **HI93735IND-0** Hardness Indicator Reagent.

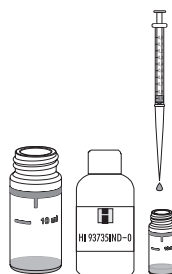

- With the plastic dropper fill the cuvette up to the 10 mL mark with **HI93735A-HR** Hardness High Range Reagent A.

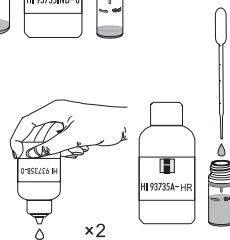

- Add two drops of **HI93735B-0** Hardness Buffer Reagent B. Replace the cap and invert 5 times to mix.

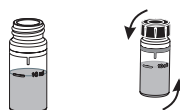

- Place the cuvette into the holder and close the lid.

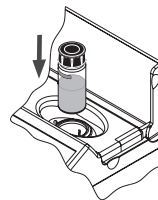

- Press the **Zero** key. The display will show “-0.0-” when the meter is zeroed and ready for measurement.

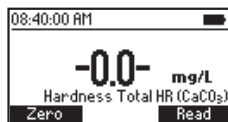
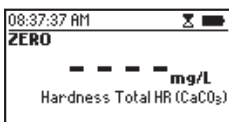
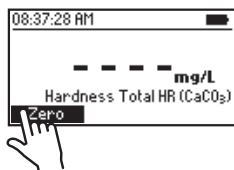

- Remove the cuvette and add one packet of **HI93735C-0** Fixing Reagent. Replace the cap and shake gently to mix 20 seconds.

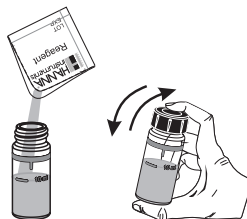

- Place the cuvette into the holder and close the lid.

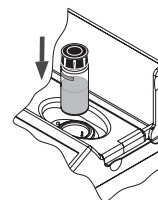

- Press **Read** to start the reading. The instrument displays concentration in **mg/L** of calcium carbonate (CaCO_3).

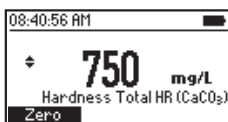
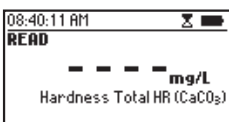
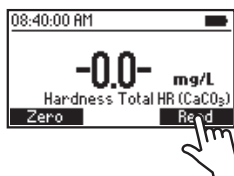

- Press **▲** or **▼** to access the second level functions.

- Press the Chem Frm key to convert the result to French degrees ($^{\circ}\text{f}$), English degrees ($^{\circ}\text{E}$) and German degrees ($^{\circ}\text{dH}$).

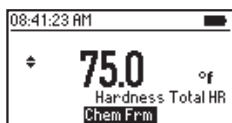
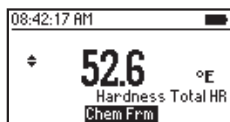
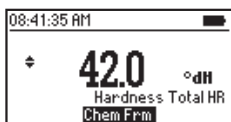

- Press ▲ or ▼ to return to the measurement screen.

INTERFERENCES

Interferences may be caused by excessive amounts of heavy metals

8.30. HYDRAZINE

SPECIFICATIONS

| | |
|--------------|--|
| Range | 0 to 400 $\mu\text{g/L}$ (as N_2H_4) |
| Resolution | 1 $\mu\text{g/L}$ |
| Accuracy | $\pm 4\%$ of full scale reading at 25 $^\circ\text{C}$ |
| Light Source | LED with narrow band interference filter @ 466 nm |
| Method | Adaptation of the ASTM Manual of Water and Environmental Technology, method D1385, p-Dimethylaminobenzaldehyde method. |

REQUIRED REAGENT

| Code | Description | Quantity |
|-----------|-------------------|----------|
| HI93704-0 | Hydrazine Reagent | 24 drops |

REAGENT SETS

HI93704-01 Reagents for 100 tests

HI93704-03 Reagents for 300 tests

For other accessories see page 200.

MEASUREMENT PROCEDURE

- Select the [Hydrazine](#) method using the procedure described in the Method Selection section (see page 18).

- Fill cuvette (#1) with 10 mL of deionized water (up to the mark).



- Fill a second cuvette (#2) with 10 mL of unreacted sample (up to the mark).



- Add 12 drops of the [HI93704-0](#) reagent to each cuvette. Replace the caps and shake gently to mix (about 30 seconds).

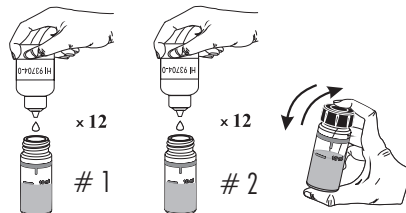

- Place the cuvette (#1) into the holder and close the lid.

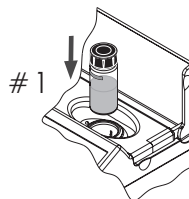

- Press **Timer** and the display will show the countdown prior to zeroing the blank or, alternatively wait for 12 minutes and press **Zero**. The display will show “-0.0-” when the meter is zeroed and ready for measurement.

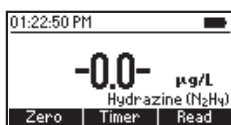
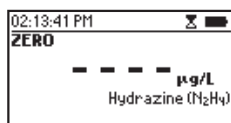
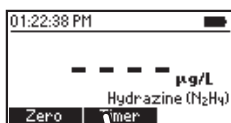

- Remove the blank.
- Insert the cuvette with the reacted sample (#2) into the instrument and close the lid.

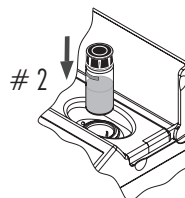

- Press **Read** to start the reading. The instrument displays concentration in $\mu\text{g/L}$ of hydrazine (N_2H_4).

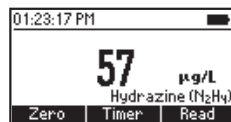
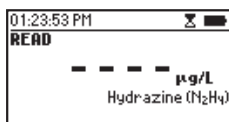

INTERFERENCES

Interference may be caused by: highly colored samples, highly turbid samples, aromatic amines.

8.31. IODINE

SPECIFICATIONS

| | |
|--------------|---|
| Range | 0.0 to 12.5 mg/L (as I ₂) |
| Resolution | 0.1 mg/L |
| Accuracy | ±0.1 mg/L ±5% of reading at 25 °C |
| Light Source | LED with narrow band interference filter @ 525 nm |
| Method | Adaptation of the Standard Methods for the Examination of Water and Wastewater, 18th edition, DPD method. |

REQUIRED REAGENTS

| Code | Description | Quantity |
|-----------|----------------|----------|
| HI93718-0 | Iodine Reagent | 1 packet |

REAGENT SETS

HI93718-01 Reagents for 100 tests

HI93718-03 Reagents for 300 tests

For other accessories see page 200.

MEASUREMENT PROCEDURE

- Select the **Iodine** method using the procedure described in the Method Selection section (see page 18).
- Fill the cuvette with 10 mL of unreacted sample (up to the mark) and replace the cap.
- Place the cuvette into the holder and close the lid.

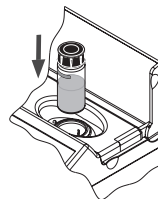

- Press the **Zero** key. The display will show “-0.0-” when the meter is zeroed and ready for measurement.

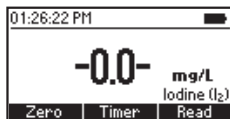
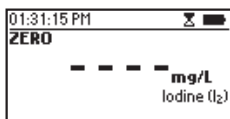
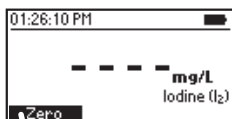

- Remove the cap and add one packet of **HI93718-0** Iodine Reagent. Replace the cap and shake gently for about 20 seconds to dissolve most of the reagent.

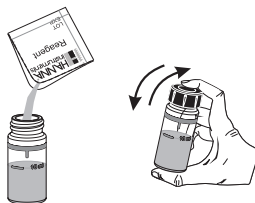

- Reinsert the cuvette into the instrument and close the lid.

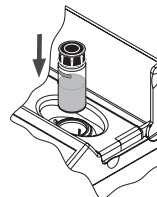

- Press **Timer** and the display will show the countdown prior to the measurement or, alternatively, wait for 2 minutes and 30 seconds and press **Read**. When the timer ends the meter will perform the reading. The instrument displays the concentration in **mg/L of iodine (I₂)**.

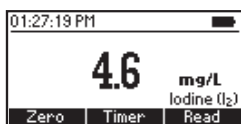
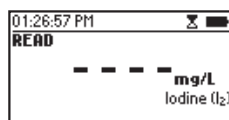
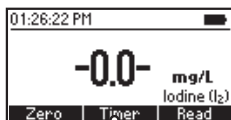

INTERFERENCES

Interference may be caused by: Bromine, Chlorine, Ozone, Oxidized forms of Chromium and Manganese.

In case of water with hardness greater than 500 mg/L CaCO₃, shake the sample for approximately 2 minutes after adding the reagent.

In case of water with alkalinity greater than 250 mg/L CaCO₃ or acidity greater than 150 mg/L CaCO₃, the color of the sample may develop only partially, or may rapidly fade. To resolve this, neutralize the sample with diluted HCl or NaOH.

8.32. IRON LOW RANGE

SPECIFICATIONS

| | |
|--------------|---|
| Range | 0.000 to 1.600 mg/L (as Fe) |
| Resolution | 0.001 mg/L |
| Accuracy | ± 0.010 mg/L $\pm 8\%$ of reading at 25 °C |
| Light Source | LED with narrow band interference filter @ 575 nm |
| Method | Adaptation of the TPTZ Method. |

REQUIRED REAGENTS

| Code | Description | Quantity |
|-----------|------------------------|-----------|
| HI93746-0 | Iron Low Range Reagent | 2 packets |

REAGENT SETS

| | |
|------------|------------------------|
| HI93746-01 | Reagents for 50 tests |
| HI93746-03 | Reagents for 150 tests |

For other accessories see page 200.

MEASUREMENT PROCEDURE

- Select the **Iron LR** method using the procedure described in the Method Selection section (see page 18).
- Fill one graduated mixing cylinder up to the 25 mL mark with deionized water.
- Add one packet of **HI93746-0** Iron Low Range Reagent, close the cylinder and shake vigorously for 30 seconds. This is the blank.
- Fill a cuvette with 10 mL of the blank (up to the mark) and replace the cap.
- Place the cuvette into the holder and close the lid.

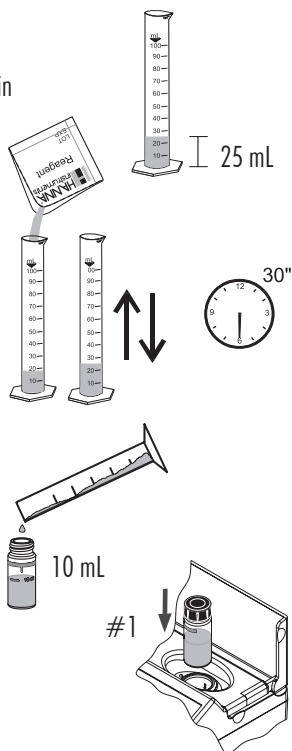

- Press the **Zero** key. The display will show “-0.0-” when the meter is zeroed and ready for measurement.

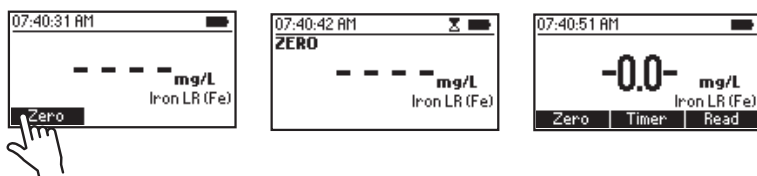

- Remove the cuvette.
- Fill another graduated mixing cylinder up to the 25 mL mark with the sample.

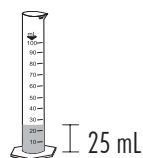

- Add one packet of **HI93746-0** Iron Low Range Reagent, close the cylinder and shake vigorously for 30 seconds. This is the reacted sample.

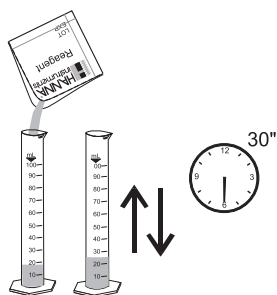

- Fill a cuvette with 10 mL of the reacted sample (up to the mark) and replace the cap.



- Insert the sample into the instrument and close the lid.

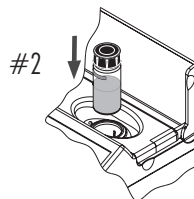

- Press **Timer** and the display will show the countdown prior to the measurement or, alternatively, wait for 30 seconds and press **Read**. When the timer ends the meter will perform the reading. The instrument displays concentration in **mg/L of iron (Fe)**.

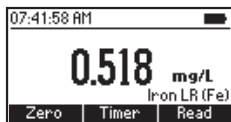
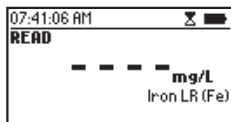
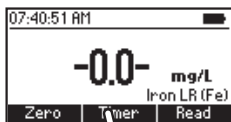

INTERFERENCES

Interference may be caused by:

Cadmium above 4.0 mg/L

Chromium³⁺ above 0.25 mg/L

Chromium⁶⁺ above 1.2 mg/L

Cobalt above 0.05 mg/L

Copper above 0.6 mg/L

Cyanide above 2.8 mg/L

Manganese above 50.0 mg/L

Mercury above 0.4 mg/L

Molybdenum above 4.0 mg/L

Nickel above 1.0 mg/L

Nitrite ion above 0.8 mg/L

Sample pH should be between 3 and 4 to avoid fading of the developed to fade or turbidity formation.

8.33. IRON HIGH RANGE

SPECIFICATIONS

| | |
|--------------|---|
| Range | 0.00 to 5.00 mg/L (as Fe) |
| Resolution | 0.01 mg/L |
| Accuracy | ± 0.04 mg/L $\pm 2\%$ of reading at 25 °C |
| Light Source | LED with narrow band interference filter @ 525 nm |
| Method | Adaptation of the EPA Phenanthroline method 315B, for natural and treated waters. |

REQUIRED REAGENTS

| Code | Description | Quantity |
|-----------|-------------------------|----------|
| HI93721-0 | Iron High Range Reagent | 1 packet |

REAGENT SETS

| | |
|------------|------------------------|
| HI93721-01 | Reagents for 100 tests |
| HI93721-03 | Reagents for 300 tests |

For other accessories see page 200.

MEASUREMENT PROCEDURE

- Select the **Iron HR** method using the procedure described in the Method Selection section (see page 18).
- Fill the cuvette with 10 mL of unreacted sample (up to the mark) and replace the cap.



- Place the cuvette into the holder and close the lid.

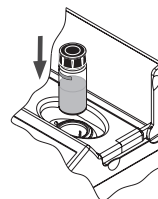

- Press the **Zero** key. The display will show “-0.0-” the meter is zeroed and ready for measurement.

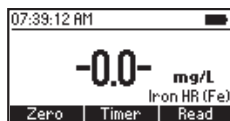
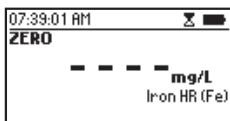
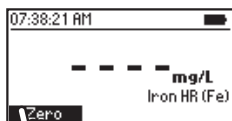

- Remove the cuvette and add the content of one packet of **HI93721-0 Iron High Range Reagent**. Replace the cap and shake until powder is completely dissolved.



- Reinsert the cuvette into the instrument and close the lid.

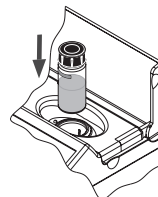

- Press **Timer** and the display will show the countdown prior to the measurement or, alternatively, wait for 3 minutes and press **Read**. When the timer ends the meter will perform the reading. The instrument displays the result in **mg/L of iron (Fe)**.

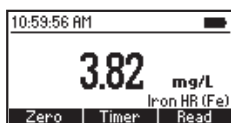
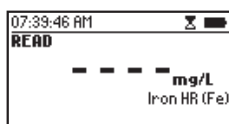

INTERFERENCES

Interference may be caused by:

Molybdate Molybdenum above 50 ppm

Calcium above 10000 ppm (as CaCO_3)

Magnesium above 100000 ppm (as CaCO_3)

Chloride above 185000 ppm.

8.34. MAGNESIUM

SPECIFICATIONS

| | |
|--------------|---|
| Range | 0 to 150 mg/L (as Mg ²⁺) |
| Resolution | 1 mg/L |
| Accuracy | ± 5 mg/L ± 3% of reading at 25 °C |
| Light Source | LED with narrow band interference filter @ 466 nm |
| Method | Adaptation of the Calmagite method. |

REQUIRED REAGENTS

| Code | Description | Quantity |
|-------------|---------------------|----------|
| HI93752A-Mg | Magnesium Reagent A | 1 mL |
| HI93752B-Mg | Magnesium Reagent B | 9 mL |

REAGENT SETS

| | |
|-------------|------------------------|
| HI937520-01 | Reagents for 50 tests |
| HI937520-03 | Reagents for 150 tests |

For other accessories see page 200.

MEASUREMENT PROCEDURE

- Select the **Magnesium** method using the procedure described in the Method Selection section (see page 18).

- Add 1 mL of **HI93752A-Mg** Magnesium Reagent A to the cuvette using a 1 mL syringe and use the pipette to fill the cuvette up to the 10 mL mark with the **HI93752B-Mg** Magnesium Reagent B.

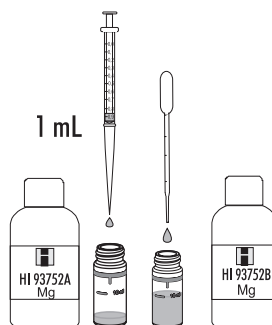

- Replace the cap and invert several times to mix.



- Place the cuvette into the holder and close the lid.

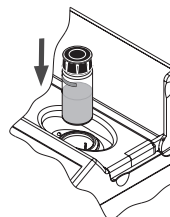

- Press the **Zero** key. The display will show “-0.0-” when the meter is zeroed and ready for measurement.

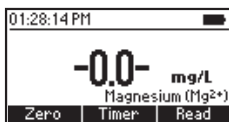
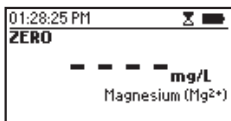
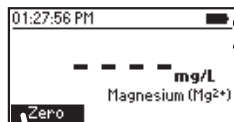

- Remove the cuvette.
- Add 0.5 mL of sample to the cuvette using the second 1 mL syringe.

0.5 mL
of sample



- Replace the cap and invert several times to mix.

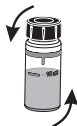

- Reinsert the cuvette into the instrument and close the lid.

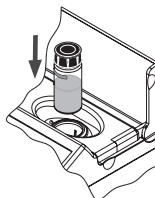

- Press **Timer** and the display will show the countdown prior to the measurement or, alternatively, wait for 15 seconds and press **Read**. When the timer ends the meter will perform the reading. The instrument displays the results in **mg/L of magnesium (Mg^{2+})**.

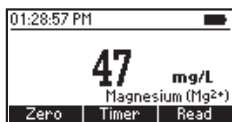
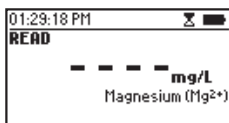
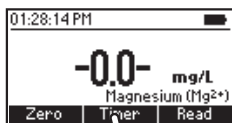

INTERFERENCES

Interferences may be caused by: acidity (as $CaCO_3$) above 1000 mg/L, alkalinity (as $CaCO_3$) above 1000 mg/L, Calcium (Ca^{2+}) above 200 mg/L, Iron must be absent, Aluminum must be absent, Copper must be absent.

8.35. MANGANESE LOW RANGE

SPECIFICATIONS

| | |
|--------------|--|
| Range | 0 to 300 $\mu\text{g/L}$ (as Mn) |
| Resolution | 1 $\mu\text{g/L}$ |
| Accuracy | $\pm 10 \mu\text{g/L} \pm 3\%$ of reading at 25 °C |
| Light Source | LED with narrow band interference filter @ 575 nm |
| Method | Adaptation of the PAN Method. |

REQUIRED REAGENTS

| Code | Description | Quantity |
|------------|-------------------------------|-----------|
| HI93748A-0 | Manganese Low Range Reagent A | 2 packets |
| HI93748B-0 | Manganese Low Range Reagent B | 0.40 mL |
| HI93748C-0 | Manganese Low Range Reagent C | 2 mL |
| HI93703-51 | Dispersing Agent | 6 drops |

REAGENT SETS

| | |
|------------|------------------------|
| HI93748-01 | Reagents for 50 tests |
| HI93748-03 | Reagents for 150 tests |

For other accessories see page 200.

MEASUREMENT PROCEDURE

- Select the **Manganese LR** method using the procedure described in the Method Selection section (see page 18).

- Fill one cuvette (#1) with 10 mL of deionized water (up to the mark).

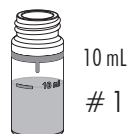

- Fill a second cuvette (#2) with 10 mL of sample (up to the mark).



- Add one packet of **HI93748A-0** Manganese Low Range Reagent A to each cuvette, replace the caps and shake gently until completely dissolved.

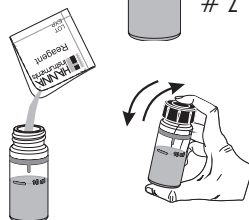

- Add 0.2 mL of the **HI93748B-0** Manganese Low Range Reagent B to each cuvette, replace the caps and invert gently to mix for about 30 seconds.

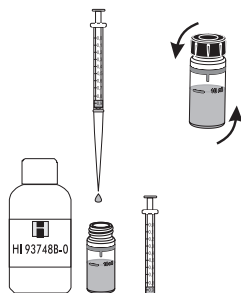

- Add 1 mL of the **HI93748C-0** Manganese Low Range Reagent C to each cuvette, replace the caps and shake gently.

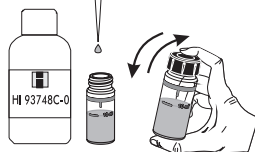

- Add 3 drops of **HI93703-51** Dispersing Agent to each cuvette, replace the caps and invert gently to mix for about 30 seconds.

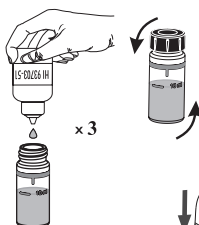

- Place the first cuvette (#1) with the reacted deionized water into the holder and close the lid.

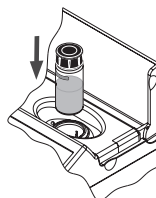

- Press **Timer** and the display will show the countdown prior to zeroing the blank. Alternatively wait for 2 minutes and then press **Zero**. The display will show “-0.0-” when the meter is zeroed and ready for measurement.

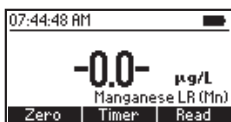
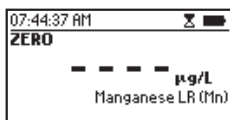
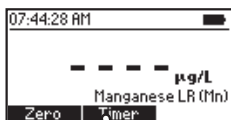

- Insert the second cuvette (#2) with the reacted sample into the instrument.

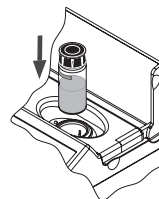

- Press **Read** to start the reading. The instrument displays the results in $\mu\text{g/L}$ of manganese (Mn).

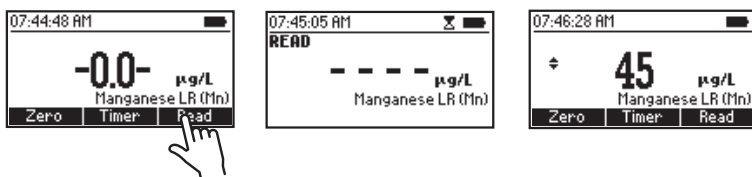

- Press **▲** or **▼** to access the second level functions.
- Press the **Chem Frm** key to convert the result to $\mu\text{g/L}$ of potassium permanganate (KMnO_4) and permanganate (MnO_4^-).

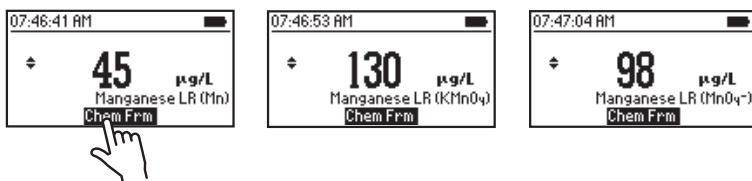

- Press **▲** or **▼** to return to the measurement screen.

INTERFERENCES

Interference may be caused by:

Aluminum above 20 mg/L

Cadmium above 10 mg/L

Calcium above 200 mg/L as CaCO_3

Cobalt above 20 mg/L

Copper above 50 mg/L

Iron above 10 mg/L

Lead above 0.5 mg/L

Magnesium above 100 mg/L as CaCO_3

Nickel above 40 mg/L

Zinc above 15 mg/L

8.36. MANGANESE HIGH RANGE

SPECIFICATIONS

| | |
|--------------|---|
| Range | 0.0 to 20.0 mg/L (as Mn) |
| Resolution | 0.1 mg/L |
| Accuracy | ±0.2 mg/L ± 3% of reading at 25 °C |
| Light Source | LED with narrow band interference filter @ 525 nm |
| Method | Adaptation of the Standard Methods for the Examination of Water and Wastewater, 18th edition, Periodate method. |

REQUIRED REAGENTS

| Code | Description | Quantity |
|------------|--------------------------------|----------|
| HI93709A-0 | Manganese High Range Reagent A | 1 packet |
| HI93709B-0 | Manganese High Range Reagent B | 1 packet |

REAGENT SETS

| | |
|------------|------------------------|
| HI93709-01 | Reagents for 100 tests |
| HI93709-03 | Reagents for 300 tests |

For other accessories see page 200.

MEASUREMENT PROCEDURE

- Select the **Manganese HR** method using the procedure described in the Method Selection section (see page 18).
- Fill the cuvette with 10 mL of unreacted sample (up to the mark) and replace the cap.
- Place the cuvette into the holder and close the lid.
- Press the **Zero** key. The display will show “-0.0-” when the meter is zeroed and ready for measurement.

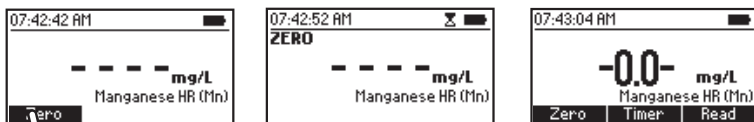
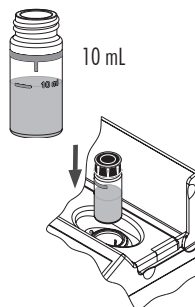

- Remove the cuvette.
- Add one packet of **HI93709A-0** Manganese High Range Reagent A. Replace the cap and shake gently for 2 minutes to mix.

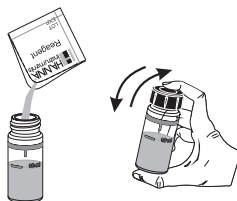

- Add one packet of **HI93709B-0** Manganese High Range Reagent B. Replace the cap and shake gently for 2 minutes to mix.

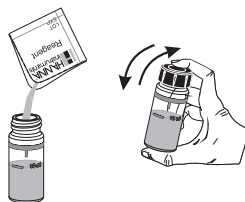

- Reinsert the cuvette into the instrument and close the lid.

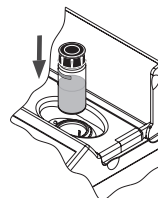

- Press **Timer** and the display will show the countdown prior to the measurement or, alternatively, wait for 1 minute and 30 seconds and press **Read**. When the timer ends the meter will perform the reading. The instrument displays the results in **mg/L of manganese (Mn)**.

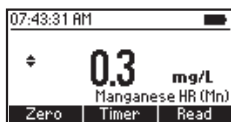
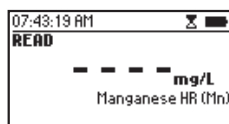
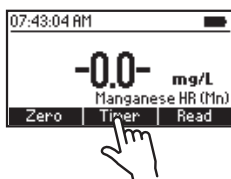

- Press **▲** or **▼** to access the second level functions.
- Press **Chem Frm** key to convert the result to **mg/L potassium permanganate (KMnO₄)** and **permanganate (MnO₄⁻)**.

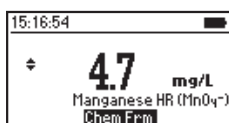
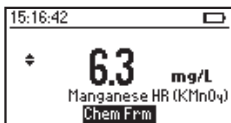
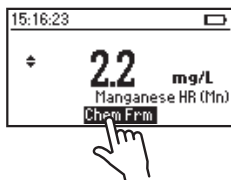

- Press **▲** or **▼** to return to the measurement screen.

INTERFERENCES

Interference may be caused by:

Calcium above 700 mg/L

Chloride above 70000 mg/L

Iron above 5 mg/L

Magnesium above 100000 mg/L

8.37. MOLYBDENUM

SPECIFICATIONS

| | |
|--------------|---|
| Range | 0.0 to 40.0 mg/L (as Mo ⁶⁺) |
| Resolution | 0.1 mg/L |
| Accuracy | ±0.3 mg/L ±5% of reading at 25 °C |
| Light Source | LED with narrow band interference filter @ 420 nm |
| Method | Adaptation of the mercaptoacetic acid method. |

REQUIRED REAGENTS

| Code | Description | Quantity |
|------------|----------------------|----------|
| HI93730A-0 | Molybdenum Reagent A | 1 packet |
| HI93730B-0 | Molybdenum Reagent B | 1 packet |
| HI93730C-0 | Molybdenum Reagent C | 1 packet |

REAGENT SETS

| | |
|------------|------------------------|
| HI93730-01 | Reagents for 100 tests |
| HI93730-03 | Reagents for 300 tests |

For other accessories see page 200.

MEASUREMENT PROCEDURE

- Select the **Molybdenum** method using the procedure described in the Method Selection section (see page 18).

- Fill the cuvette with 10 mL of unreacted sample (up to the mark) and replace the cap.

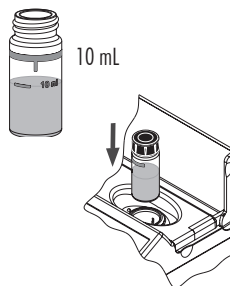

- Place the cuvette into the holder and close the lid.

- Press the **Zero** key. The display will show “-0.0-” when the meter is zeroed and ready for measurement.

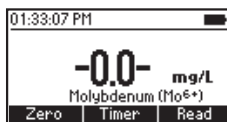
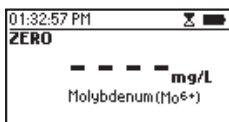
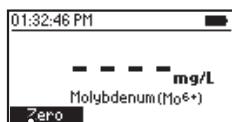

- Fill one graduated mixing cylinder up to the 25 mL mark with the sample.

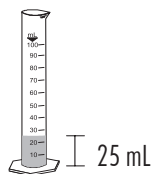

- Add one packet of **HI93730A-0** Molybdenum Reagent A, close the cylinder and invert several times until completely dissolved.

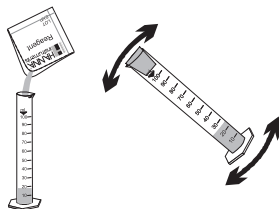

- Add one packet of **HI93730B-0** Molybdenum Reagent B to the cylinder, close and invert several times until completely dissolved.

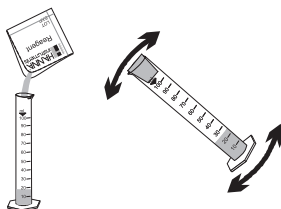

- Add one packet of **HI93730C-0** Molybdenum Reagent C to the cylinder, close and shake vigorously.

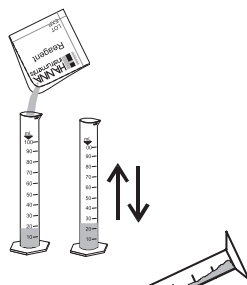

- Fill an empty cuvette with 10 mL of reacted sample (up to the mark) and replace the cap.



- Insert the cuvette into the instrument and close the lid.

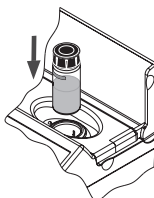

- Press **Timer** and the display will show the countdown prior to the measurement or, alternatively, wait for 5 minutes and press **Read**. When the timer ends the meter will perform the reading. The instrument displays concentration in **mg/L of molybdenum (Mo^{6+})**.

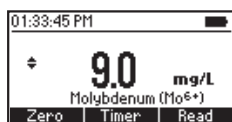

- Press **▲** or **▼** to access the second level functions.
- Press the **Chem Frm** key to convert the result to **mg/L of molybdate (MoO_4^{2-}) and sodium molybdate (Na_2MoO_4)**.

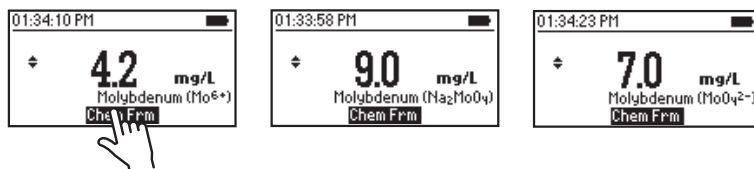

- Press **▲** or **▼** to return to the measurement screen.

INTERFERENCES

Interference may be caused by:

Aluminum above 50 mg/L

Chromium above 1000 mg/L

Copper above 10 mg/L

Iron above 50 mg/L

Nickel above 50 mg/L

Nitrite, as NO_2^-

Sulfate above 200 mg/L

Highly buffered samples or with extreme pH may exceed the buffering capacity of the reagents

8.38. NICKEL LOW RANGE

SPECIFICATIONS

| | |
|--------------|---|
| Range | 0.000 to 1.000 mg/L (as Ni) |
| Resolution | 0.001 mg/L |
| Accuracy | ±0.010 mg/L ±7% of reading at 25 °C |
| Light Source | LED with narrow band interference filter @ 575 nm |
| Method | Adaptation of the PAN method. |

REQUIRED REAGENTS

| Code | Description | Quantity |
|------------|-------------------------------------|-----------|
| HI93740A-0 | Nickel Low Range Reagent A | 2 packets |
| HI93740B-0 | Nickel Low Range Reagent B | 2 mL |
| HI93740C-0 | Nickel Low Range Reagent C | 2 packets |
| HI93703-51 | Dispersing Agent (optional reagent) | 4-6 drops |

REAGENT SETS

| | |
|------------|------------------------|
| HI93740-01 | Reagents for 50 tests |
| HI93740-03 | Reagents for 150 tests |

For other accessories see page 200.

MEASUREMENT PROCEDURE

- Select the **Nickel LR** method using the procedure described in the Method Selection section (see page 18).

Note: For best results samples should be between 20 and 24 °C.

- Fill one graduated beaker with 25 mL of deionized water (blank) and another one with 25 mL of sample.
- Add one packet of **HI93740A-0** Nickel Low Range Reagent A to each beaker. Cap and swirl gently until the reagent is dissolved.

Note: If sample contains iron (Fe^{3+}), it is important that all powder is dissolved before continuing.

- Add 1 mL of **HI93740B-0** Nickel Low Range Reagent B to each beaker, and swirl to mix.

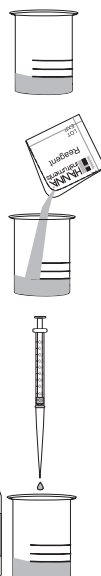

- Press **Timer** and the display will show a countdown or alternatively, wait for 15 minutes.

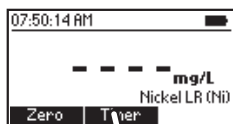

- Add one packet of **HI93740C-0** Nickel Low Range Reagent C to each beaker, cap and swirl to mix until completely dissolved.



- Fill one cuvette (#1) with 10 mL of the blank (up to the mark).



- Place the cuvette into the holder and close the lid.

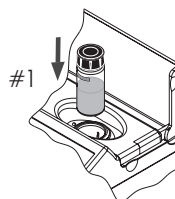

- Press the **Zero** key. The display will show “-0.0-” when the meter is zeroed and ready for measurement.

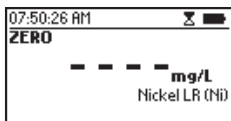
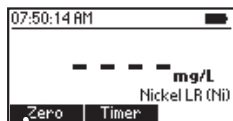

- Fill a second cuvette (#2) with 10 mL of the reacted sample (up to the mark).



- Insert the second cuvette into the instrument and close the lid.

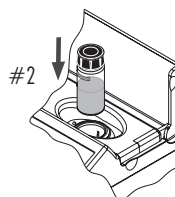

- Press **Read** to start the reading. The instrument displays the results in mg/L of nickel (Ni).

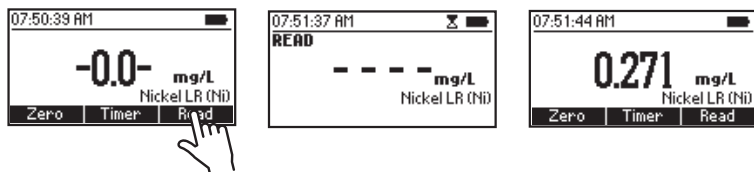

Note: A temperature above 30 °C may cause turbidity. In this case add 2-3 drops of HI93703-51 Dispersing Agent to each cuvette and swirl until turbidity is removed before zeroing the meter and reading the sample.

INTERFERENCES

Interference may be caused by:

Co²⁺ must not be present

Fe²⁺ must not be present

Al³⁺ above 32 mg/L

Ca²⁺ above 1000 mg/L (as CaCO₃)

Cd²⁺ above 20 mg/L

Cl⁻ above 8000 mg/L

Cr³⁺ above 20 mg/L

Cr⁶⁺ above 40 mg/L

Cu²⁺ above 15 mg/L

F⁻ above 20 mg/L

Fe³⁺ above 10 mg/L

K⁺ above 500 mg/L

Mg²⁺ above 400 mg/L

Mn²⁺ above 25 mg/L

Mo⁶⁺ above 60 mg/L

Na⁺ above 5000 mg/L

Pb²⁺ above 20 mg/L

Zn²⁺ above 30 mg/L

8.39. NICKEL HIGH RANGE

SPECIFICATIONS

| | |
|--------------|---|
| Range | 0.00 to 7.00 g/L (as Ni) |
| Resolution | 0.01 g/L |
| Accuracy | $\pm 0.07\text{g/L} \pm 4\%$ of reading at 25 °C |
| Light Source | LED with narrow band interference filter @ 575 nm |
| Method | Adaptation of the photometric method. |

REQUIRED REAGENTS

| Code | Description | Quantity |
|-----------|---------------------------|----------|
| HI93726-0 | Nickel High Range Reagent | 1 packet |

REAGENT SETS

| | |
|------------|------------------------|
| HI93726-01 | Reagents for 100 tests |
| HI93726-03 | Reagents for 300 tests |

For other accessories see page 200.

MEASUREMENT PROCEDURE

- Select the *Nickel HR* method using the procedure described in the Method Selection section (see page 18).

- Fill the cuvette with 10 mL of unreacted sample (up to the mark) and replace the cap.



- Place the cuvette into the holder and close the lid.

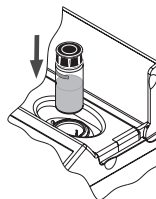

- Press the **Zero** key. The display will show “-0.0-” when the meter is zeroed and ready for measurement.

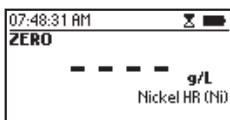
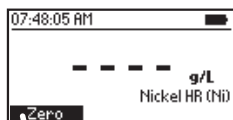

- Remove the cuvette and add one packet of **HI93726-0** Nickel High Range Reagent. Replace the cap and shake gently until completely dissolved.

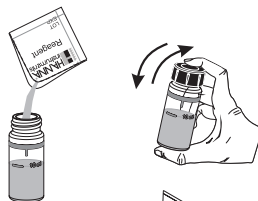

- Reinsert the cuvette into the instrument and close the lid.

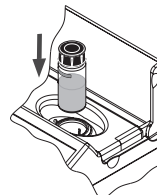

- Press **Timer** and the display will show the countdown prior to the measurement or, alternatively, wait for 1 minute and press **Read**. When the timer ends the meter will perform the reading. The instrument displays the concentration in **g/L of nickel (Ni)**.

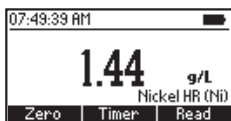
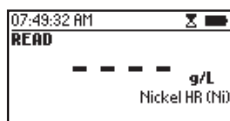
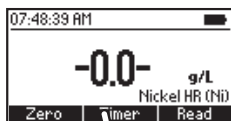

INTERFERENCES

Interference may be caused by copper.

8.40. NITRATE

SPECIFICATIONS

| | |
|--------------|--|
| Range | 0.0 to 30.0 mg/L (as $\text{NO}_3^- - \text{N}$) |
| Resolution | 0.1 mg/L |
| Accuracy | $\pm 0.5 \text{ mg/L} \pm 10\%$ of reading at 25°C |
| Light Source | LED with narrow band interference filter @ 525 nm |
| Method | Adaptation of the cadmium reduction method. |

REQUIRED REAGENTS

| Code | Description | Quantity |
|-----------|-----------------|----------|
| HI93728-0 | Nitrate Reagent | 1 packet |

REAGENT SETS

HI93728-01 Reagents for 100 tests

HI93728-03 Reagents for 300 tests

For other accessories see page 200.

MEASUREMENT PROCEDURE

- Select the **Nitrate** method using the procedure described in the Method Selection section (see page 18).

- Fill the cuvette with 10 mL of sample, (up to the mark), and replace the cap.



- Place the cuvette into the holder and close the lid.

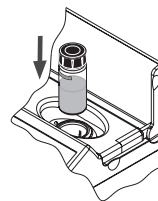

- Press the **Zero** key. The display will show “-0.0-” when the meter is zeroed and ready for measurement.

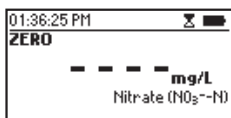
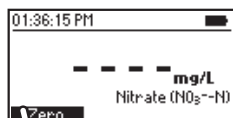

- Remove the cuvette and add one packet of **HI93728-0 Nitrate Reagent**.



- Replace the cap and shake vigorously up and down for exactly 10 seconds. Continue to mix by inverting the cuvette gently for 50 seconds, while taking care not to induce air bubbles. Powder will not completely dissolve. Time and method of shaking could sensitively affect the measurement.

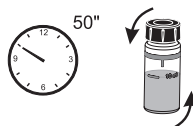
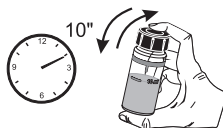

Note: The method is technique-sensitive. See procedure on page 20 Cuvette Preparation for proper mixing technique.

- Reinsert the cuvette into the instrument and close the lid.

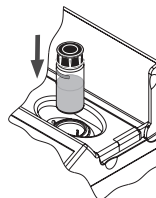

- Press **Timer** and the display will show the countdown prior to the measurement or, alternatively, wait for 4 minutes and 30 seconds and press **Read**. When the timer ends the meter will perform the reading. The instrument displays the results in **mg/L of nitrate-nitrogen (NO₃-N)**.

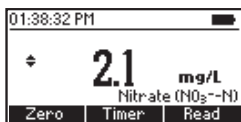
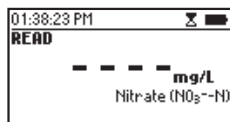
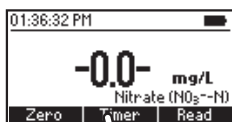

- Press **▲** or **▼** to access the second level functions.

- Press the **Chem Frm** key to convert the result to mg/L of nitrate (NO_3^-).

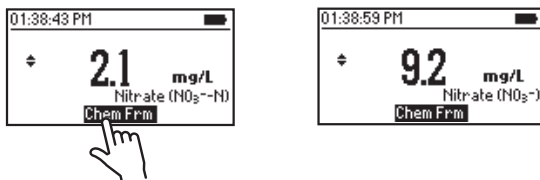

- Press ▲ or ▼ to return to the measurement screen.

INTERFERENCES

Interference may be caused by:

Ammonia and amines, as urea and primary aliphatic amines

Chloride above 100 ppm

Chlorine above 2 ppm

Copper

Iron(III)

Strong oxidizing and reducing substances

Sulfide must be absent

8.41. NITRITE, MARINE ULTRA LOW RANGE

SPECIFICATIONS

| | |
|--------------|--|
| Range | 0 to 200 $\mu\text{g/L}$ (as $\text{NO}_2^- \text{-N}$) |
| Resolution | 1 $\mu\text{g/L}$ |
| Accuracy | $\pm 10 \mu\text{g/L} \pm 4\%$ of reading at 25 °C |
| Light Source | LED with narrow band interference filter @ 466 nm |
| Method | Adaptation of the EPA Diazotization method 354.1. |

REQUIRED REAGENTS

| Code | Description | Quantity |
|----------|---------------------------------|----------|
| HI764-25 | Nitrite Ultra Low Range Reagent | 1 packet |

REAGENT SETS

HI764-25 Reagents for 25 tests
 For other accessories see page 200.

MEASUREMENT PROCEDURE

- Select the **Nitrite, Marine ULR** method using the procedure described in the Method Selection section (see page 18).
- Fill the cuvette with 10 mL of unreacted sample (up to the mark) and replace the cap.
- Place the cuvette into the holder and close the lid.
- Press the **Zero** key. The display will show “-0.0-” when the meter is zeroed and ready for measurement.

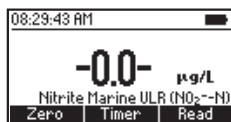
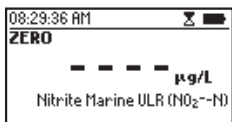
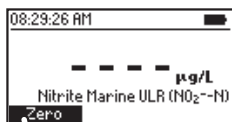
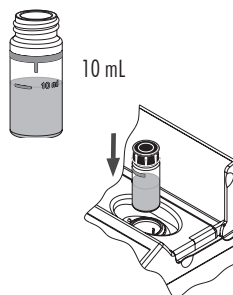

- Remove the cuvette.
- Add one packet of HI764-25 Nitrite Ultra Low Range Reagent. Replace the cap and shake gently for about 15 seconds.

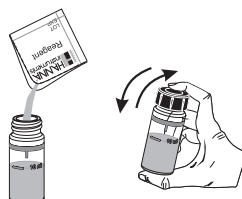

- Reinsert the cuvette into the instrument and close the lid.

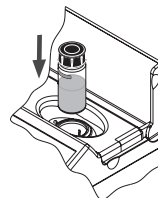

- Press **Timer** and the display will show the countdown prior to the measurement or, alternatively, wait for 15 minutes and press **Read**. When the timer ends the meter will perform the reading. The instrument displays concentration in $\mu\text{g/L}$ of nitrite-nitrogen ($\text{NO}_2^- \text{-N}$).

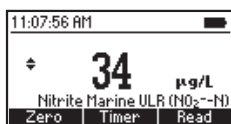
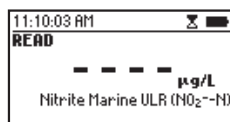
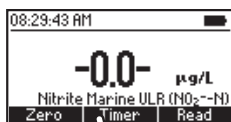

- Press \blacktriangle or \blacktriangledown to access the second level functions.
- Press the **Chem Frm** key to convert the result to $\mu\text{g/L}$ of nitrite (NO_2^-) and sodium nitrite (NaNO_2).

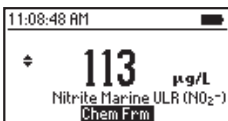
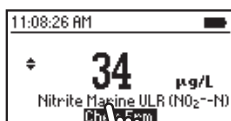

- Press \blacktriangle or \blacktriangledown to return to the measurement screen.

INTERFERENCES

Interference may be caused by the following ions: ferrous, ferric, cupric, mercurous, silver, antimonious, bismuth, auric, lead, metavanadate and chloroplatinate.

Strongly reducing and oxidizing reagents.

High levels of nitrate (above 100 mg/L) could yield falsely high readings due to a minute amount of reduction to nitrite that could occur at these levels.

8.42. NITRITE LOW RANGE

SPECIFICATIONS

| | |
|--------------|--|
| Range | 0 to 600 $\mu\text{g/L}$ (as NO_2^- -N) |
| Resolution | 1 $\mu\text{g/L}$ |
| Accuracy | $\pm 20 \mu\text{g/L} \pm 4\%$ of reading at 25 °C |
| Light Source | LED with narrow band interference filter @ 466 nm |
| Method | Adaptation of the EPA Diazotization method 354.1. |

REQUIRED REAGENTS

| Code | Description | Quantity |
|-----------|---------------------------|----------|
| HI93707-0 | Nitrite Low Range Reagent | 1 packet |

REAGENT SETS

| | |
|------------|------------------------|
| HI93707-01 | Reagents for 100 tests |
| HI93707-03 | Reagents for 300 tests |

For other accessories see page 200.

MEASUREMENT PROCEDURE

- Select the **Nitrite LR** method using the procedure described in the Method Selection section (see page 18).
- Fill the cuvette up to the mark with 10 mL of unreacted sample (up to the mark) and replace the cap.

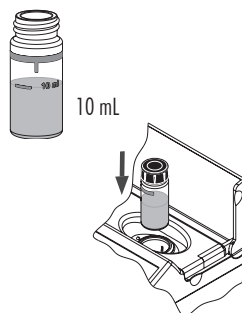

- Place the cuvette into the holder and close the lid.
- Press the **Zero** key. The display will show “-0.0-” when the meter is zeroed and ready for measurement.

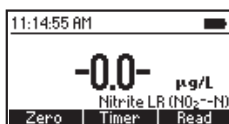
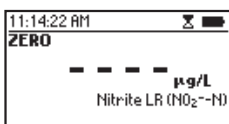
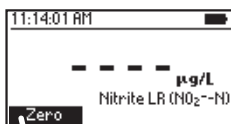

- Remove the cuvette.

- Add one packet of **HI93707-0** Nitrite Low Range Reagent. Replace the cap and shake gently for about 15 seconds.

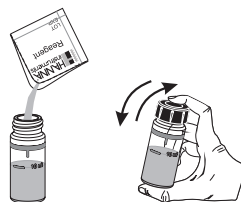

- Reinsert the cuvette into the instrument and close the lid.

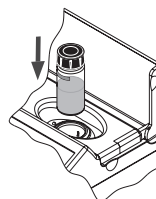

- Press **Timer** and the display will show the countdown prior to the measurement or, alternatively, wait for 15 minutes and press **Read**. When the timer ends the meter will perform the reading. The instrument displays concentration in $\mu\text{g/L}$ of nitrite-nitrogen (NO_2^--N).

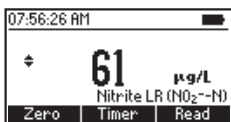
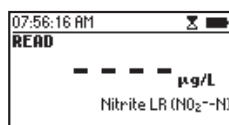
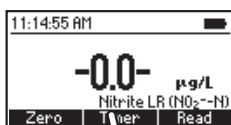

- Press \blacktriangle or \blacktriangledown to access the second level functions.
- Press the **Chem Frm** key to convert the result to $\mu\text{g/L}$ of nitrite (NO_2^-) and sodium nitrite (NaNO_2).

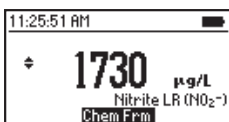
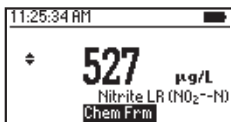

- Press \blacktriangle or \blacktriangledown to return to the measurement screen.

INTERFERENCES

Interference may be caused by the following ions: ferrous, ferric, cupric, mercurous, silver, antimonious, bismuth, auric, lead, metavanadate and chloroplatinate. Strongly reducing and oxidizing reagents.

High levels of nitrate (above 100 mg/L) could yield falsely high readings due to a minute amount of reduction to nitrite that could occur at these levels.

8.43. NITRITE HIGH RANGE

SPECIFICATIONS

| | |
|--------------|---|
| Range | 0 to 150 mg/L (as NO ₂ ⁻) |
| Resolution | 1 mg/L |
| Accuracy | ± 4 mg/L ± 4% of reading at 25 °C |
| Light Source | LED with narrow band interference filter @ 575 nm |
| Method | Adaptation of the Ferrous Sulfate method. |

REQUIRED REAGENTS

| Code | Description | Quantity |
|-----------|----------------------------|----------|
| HI93708-0 | Nitrite High Range Reagent | 1 packet |

REAGENT SETS

HI93708-01 Reagents for 100 tests

HI93708-03 Reagents for 300 tests

For other accessories see page 200.

MEASUREMENT PROCEDURE

- Select the **Nitrite HR** method using the procedure described in the Method Selection section (see page 18).
- Fill the cuvette up to the mark with 10 mL of unreacted sample (up to the mark) and replace the cap.
- Place the cuvette into the holder and close the lid.
- Press the **Zero** key. The display will show “-0.0-” when the meter is zeroed and ready for measurement.

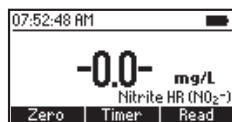
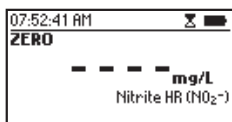
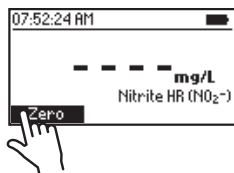
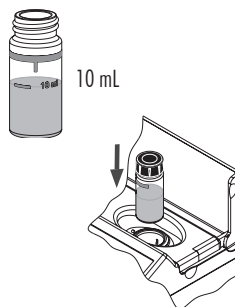

- Remove the cuvette.

- Add one packet of **HI93708-0** Nitrite High Range Reagent. Replace the cap and shake gently until completely dissolved.

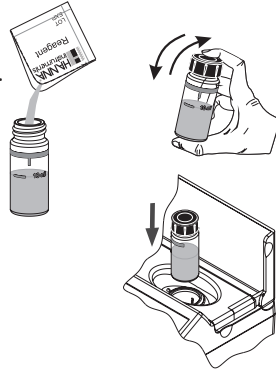

- Reinsert the cuvette into the instrument and close the lid.

- Press **Timer** and the display will show the countdown prior to the measurement or, alternatively, wait for 10 minutes and press **Read**. When the timer ends the meter will perform the reading. The instrument displays concentration in **mg/L of nitrite (NO_2^-)**.

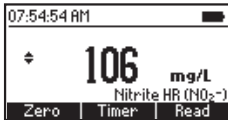
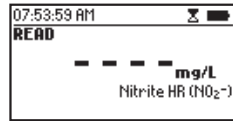
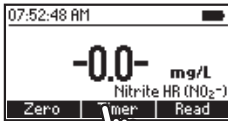

- Press **▲** or **▼** to access the second level functions.
- Press the **Chem Frm** key to convert the result to **mg/L of nitrite-nitrogen (NO_2^- -N) and sodium nitrite (NaNO_2)**.

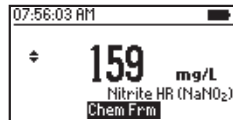
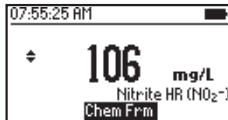
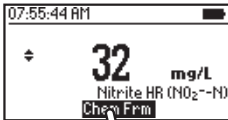

- Press **▲** or **▼** to return to the measurement screen.

8.44. OXYGEN, DISSOLVED

SPECIFICATIONS

| | |
|--------------|--|
| Range | 0.0 to 10.0 mg/L (as O ₂) |
| Resolution | 0.1 mg/L |
| Accuracy | ±0.4 mg/L ± 3% of reading at 25 °C |
| Light Source | LED with narrow band interference filter @ 420 nm |
| Method | Adaptation of the Standard Methods for the Examination of Water and Wastewater, 18th edition, Azide modified Winkler method. |

REQUIRED REAGENTS

| Code | Description | Quantity |
|------------|----------------------------|----------|
| HI93732A-0 | Dissolved Oxygen Reagent A | 5 drops |
| HI93732B-0 | Dissolved Oxygen Reagent B | 5 drops |
| HI93732C-0 | Dissolved Oxygen Reagent C | 10 drops |

REAGENT SET

HI93732-01 Reagents for 100 tests

HI93732-03 Reagents for 300 tests

For other accessories see page 200.

MEASUREMENT PROCEDURE

- Select the **Oxygen (dissolved)** method using the procedure described in the Method Selection section (see page 18).
- Fill one 60 mL glass bottle completely with the unreacted sample.
- Replace the cap and ensure that a small part of the sample spills over.
- Remove the cap and add 5 drops of **HI93732A-0** and 5 drops of **HI93732B-0**.
- Add more sample, to fill the bottle completely. Replace the cap and ensure that a part of the sample spills over.

Note: This ensures no air bubbles have been trapped inside the bottle. Trapped air bubbles could alter readings.

- Invert the bottle several times until the sample turns orange-yellow and a flocculating agent appears.

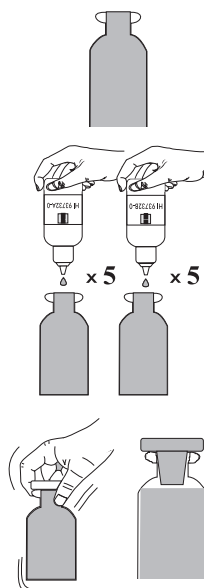

- Let the sample stand for approximately 2 minutes to allow flocculating agent to settle.
- When the upper half of the bottle is clear, add 10 drops of **HI93732C-0** Dissolved Oxygen Reagent C.

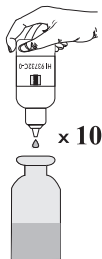

- Replace the cap and invert the bottle until the settled flocculating agent dissolves completely. The sample is ready for measurement when it is yellow and completely clear.

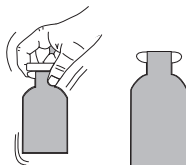

- Fill the first cuvette (#1) with 10 mL of the unreacted sample (up to the mark), and replace the cap.

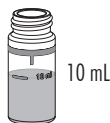

- Place the cuvette into the holder and close the lid.

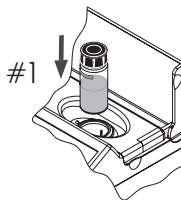

- Press the **Zero** key. The display will show “-0.0-” when the meter is zeroed and ready for measurement.

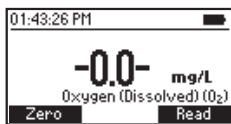
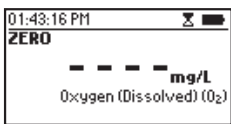
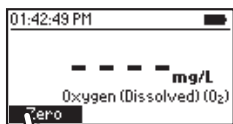

- Remove the cuvette.
- Fill second cuvette (#2) with 10 mL of the reacted sample (up to the mark) and replace the cap.



- Insert the cuvette into the holder and close the lid.

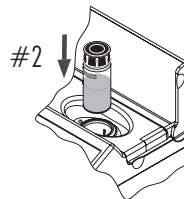

- Press **Read** to start the reading. The instrument will display the results in mg/L of oxygen (O_2).

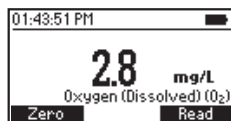
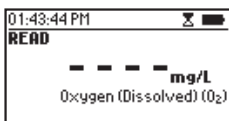
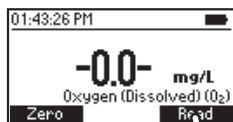

INTERFERENCES

Interferences may be caused by reducing and oxidizing materials.

8.45. OXYGEN SCAVENGERS (CARBOHYDRAZIDE)

SPECIFICATIONS

| | |
|--------------|---|
| Range | 0.00 to 1.50 mg/L (as Carbohydrazide) |
| Resolution | 0.01 mg/L |
| Accuracy | ± 0.02 mg/L $\pm 3\%$ of reading at 25 °C |
| Light Source | LED with narrow band interference filter @ 575 nm |
| Method | Adaptation of the iron reduction method. |

REQUIRED REAGENTS

| Code | Description | Quantity |
|------------|-----------------------------|-----------|
| HI96773A-0 | Oxygen Scavengers Reagent A | 2 packets |
| HI96773B-0 | Oxygen Scavengers Reagent B | 1 mL |

REAGENT SET

| | |
|------------|------------------------|
| HI96773-01 | Reagents for 50 tests |
| HI96773-03 | Reagents for 150 tests |

For other accessories see page 200.

MEASUREMENT PROCEDURE

- Select the [Oxy. Scavengers \(Carbohy\)](#) method using the procedure described in the Method Selection section (see page 18).

- Fill first cuvette (#1) with 10 mL of deionized water (up to the mark).

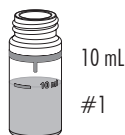

- Fill second cuvette (#2) with 10 mL of sample (up to the mark).

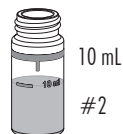

- Add one packet of HI96773A-0 Oxygen Scavengers Reagent A to cuvette #1. Replace the cap and invert for 30 seconds.

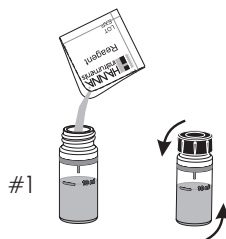

- Add one packet of **HI96773A-0** Oxygen Scavengers Reagent A to cuvette (#2). Replace the cap and invert for 30 seconds.

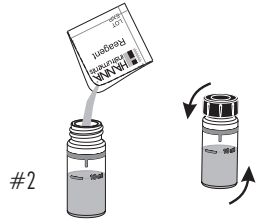

- Add 0.5 mL of **HI96773B-0** Oxygen Scavengers Reagent B to each cuvette using the 1 mL syringe.

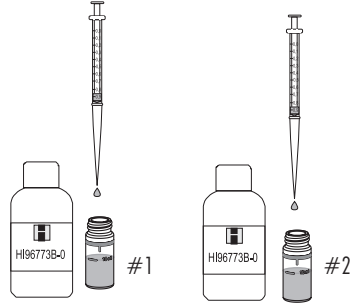

- Replace the caps and invert for 10 seconds.



- Place first cuvette (#1) into the holder and close the lid.

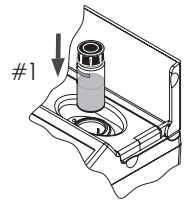

- Press **Timer** and the display will show countdown prior to the measurement or, alternatively, wait for 10 minutes and press **Zero**. The display will show “-0.0-” when the meter is zeroed and ready for measurement.

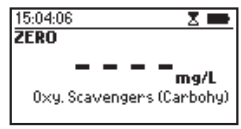
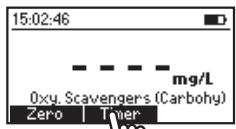

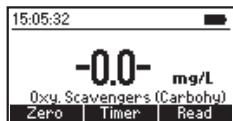

- Remove the cuvette.
- Insert the second cuvette (#2) into the instrument and close the lid.

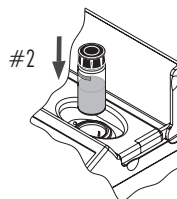

- Press **Read** to start reading. The instrument displays the results in **mg/L of carbonylhydrazide**.

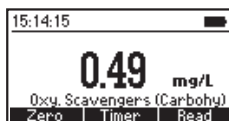
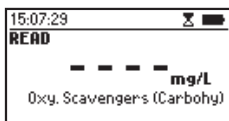
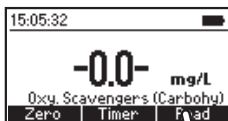

INTERFERENCES

Interference may be caused by:

Borate (as $\text{Na}_2\text{B}_4\text{O}_7$), Cobalt, Copper, Iron (Ferrous), Hardness (as CaCO_3), Light, Lignosulfonates, Manganese, Molybdenum, Nickel, Phosphate, Phosphonates, Sulfate, Temperature, and Zinc.

8.46. OXYGEN SCAVENGERS (DEHA)

SPECIFICATIONS

| | |
|--------------|---|
| Range | 0 to 1000 $\mu\text{g/L}$ (as DEHA) |
| Resolution | 1 $\mu\text{g/L}$ |
| Accuracy | $\pm 5 \mu\text{g/L} \pm 5\%$ of reading at 25 °C |
| Light Source | LED with narrow band interference filter @ 575 nm |
| Method | Adaptation of the iron reduction method. |

REQUIRED REAGENTS

| Code | Description | Quantity |
|------------|-----------------------------|-----------|
| HI96773A-0 | Oxygen Scavengers Reagent A | 2 packets |
| HI96773B-0 | Oxygen Scavengers Reagent B | 1 mL |

REAGENT SET

| | |
|------------|------------------------|
| HI96773-01 | Reagents for 50 tests |
| HI96773-03 | Reagents for 150 tests |

For other accessories see page 200.

MEASUREMENT PROCEDURE

- Select the [Oxy. Scavengers \(DEHA\)](#) method using the procedure described in the Method Selection section (see page 18).
- Fill first cuvette (#1) with 10 mL of deionized water (up to the mark).
- Fill second cuvette (#2) with 10 mL of sample (up to the mark).
- Add one packet of HI96773A-0 Oxygen Scavengers Reagent A to (#1) cuvette. Replace the cap and invert for 30 seconds.

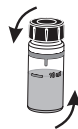
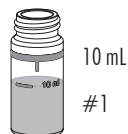

- Add one packet of **HI96773A-0** Oxygen Scavengers Reagent A to (#2) cuvette. Replace the cap and invert for 30 seconds.

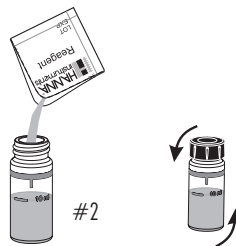

- Add 0.5 mL of **HI96773B-0** Oxygen Scavengers Reagent B to each cuvette using the 1 mL syringe.

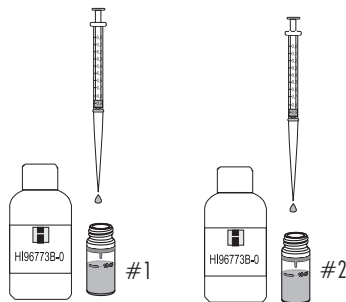

- Replace the caps and invert for 10 seconds.



- Place first cuvette (#1) into the holder and close the lid.

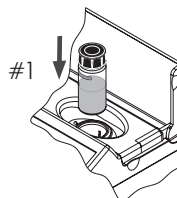

- Press **Timer** and the display will show countdown prior to the measurement or, alternatively, wait for 10 minutes and press **Zero**. The display will show “-0.0-” when the meter is zeroed and ready for measurement.

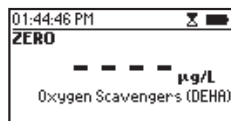
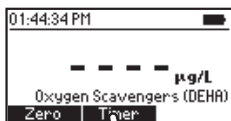

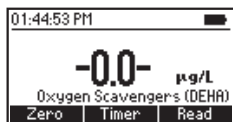

- Remove the cuvette.
- Insert the second cuvette (#2) into the holder and close the lid.

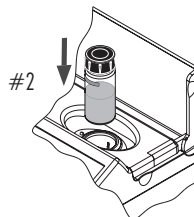

- Press **Read** to start reading. The instrument displays the results in $\mu\text{g/L}$ of DEHA.

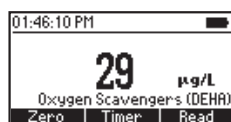
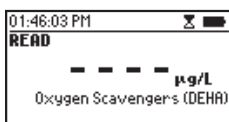
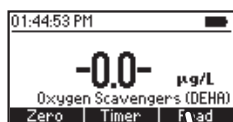

INTERFERENCES

Interference may be caused by:

Borate (as $\text{Na}_2\text{B}_4\text{O}_7$), Cobalt, Copper, Iron (Ferrous), Hardness (as CaCO_3), Light, Lignosulfonates, Manganese, Molybdenum, Nickel, Phosphate, Phosphonates, Sulfate, Temperature, and Zinc.

8.47. OXYGEN SCAVENGERS (HYDROQUINONE)

SPECIFICATIONS

| | |
|--------------|---|
| Range | 0.00 to 2.50 mg/L (as Hydroquinone) |
| Resolution | 0.01 mg/L |
| Accuracy | ± 0.04 mg/L $\pm 3\%$ of reading at 25 °C |
| Light Source | LED with narrow band interference filter @ 575 nm |
| Method | Adaptation of the iron reduction method. |

REQUIRED REAGENTS

| Code | Description | Quantity |
|------------|-----------------------------|-----------|
| HI96773A-0 | Oxygen Scavengers Reagent A | 2 packets |
| HI96773B-0 | Oxygen Scavengers Reagent B | 1 mL |

REAGENT SET

| | |
|------------|------------------------|
| HI96773-01 | Reagents for 50 tests |
| HI96773-03 | Reagents for 150 tests |

For other accessories see page 200.

MEASUREMENT PROCEDURE

- Select the [Oxy. Scavengers \(Hydro\)](#) method using the procedure described in the Method Selection section (see page 18).

- Fill first cuvette (#1) with 10 mL of deionized water (up to the mark).



- Fill second cuvette (#2) with 10 mL of sample (up to the mark).

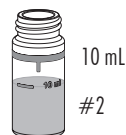

- Add one packet of HI96773A-0 Oxygen Scavengers Reagent A to #1 cuvette. Replace the cap and invert for 30 seconds.

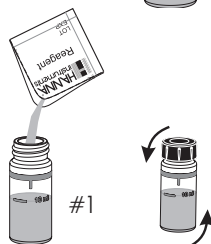

- Add one packet of HI96773A-0 Oxygen Scavengers Reagent A to (#2) cuvette. Replace the cap and invert for 30 seconds.

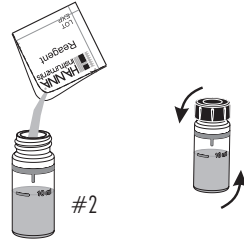

- Add 0.5 mL of HI96773B-0 Oxygen Scavengers Reagent B to each cuvette using the 1 mL syringe.

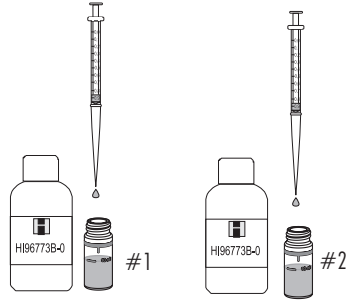

- Replace the caps and invert for 10 seconds.



- Place first cuvette (#1) into the holder and close the lid.

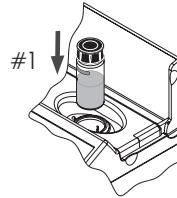

- Press **Timer** and the display will show countdown prior to the measurement or, alternatively, wait for 2 minutes and press **Zero**. The display will show “-0.0-” when the meter is zeroed and ready for measurement.

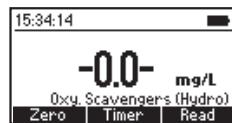
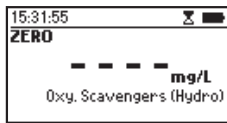
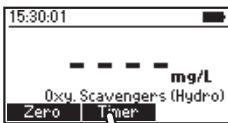

- Remove the cuvette.
- Insert the second cuvette (# 2) into the holder and close the lid.

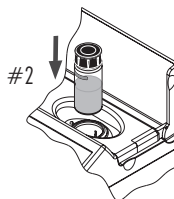

- Press **Read** to start reading. The instrument displays the results in **mg/L of hydroquinone**.

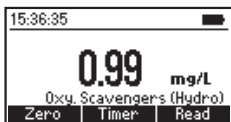
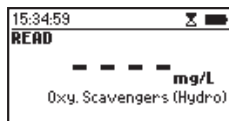
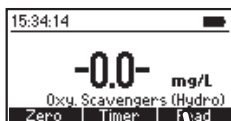

INTERFERENCES

Interference may be caused by:

Borate (as $\text{Na}_2\text{B}_4\text{O}_7$), Cobalt, Copper, Iron (Ferrous), Hardness (as CaCO_3), Light, Lignosulfonates, Manganese, Molybdenum, Nickel, Phosphate, Phosphonates, Sulfate, Temperature, and Zinc.

8.48. OXYGEN SCAVENGERS (ISO-ASCORBIC ACID)

SPECIFICATIONS

| | |
|--------------|---|
| Range | 0.00 to 4.50 mg/L (as Iso-ascorbic acid) |
| Resolution | 0.01 mg/L |
| Accuracy | ± 0.03 mg/L ± 3 % of reading at 25 °C |
| Light Source | LED with narrow band interference filter @ 575 nm |
| Method | Adaptation of the iron reduction method |

REQUIRED REAGENTS

| Code | Description | Quantity |
|------------|-----------------------------|-----------|
| HI96773A-0 | Oxygen Scavengers Reagent A | 2 packets |
| HI96773B-0 | Oxygen Scavengers Reagent B | 1 mL |

REAGENT SET

| | |
|------------|------------------------|
| HI96773-01 | Reagents for 50 tests |
| HI96773-03 | Reagents for 150 tests |

For other accessories see page 200.

MEASUREMENT PROCEDURE

- Select the [Oxy. Scavengers \(ISA\)](#) method using the procedure described in the Method Selection section (see page 18).

- Fill first cuvette (#1) with 10 mL of deionized water (up to the mark).

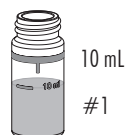

- Fill second cuvette (#2) with 10 mL of sample (up to the mark).

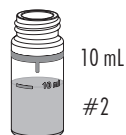

- Add one packet of HI96773A-0 Oxygen Scavengers Reagent A to (#1) cuvette. Replace the cap and invert for 30 seconds.

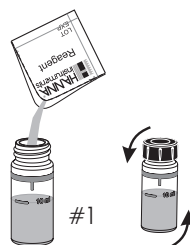

- Add one packet of **HI96773A-0** Oxygen Scavengers Reagent A to (#2) cuvette. Replace the cap and invert for 30 seconds.

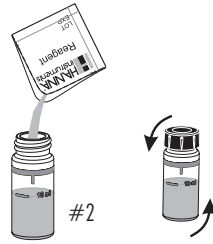

- Add 0.5 mL of **HI96773B-0** Oxygen Scavengers Reagent B to each cuvette using the 1 mL syringe.

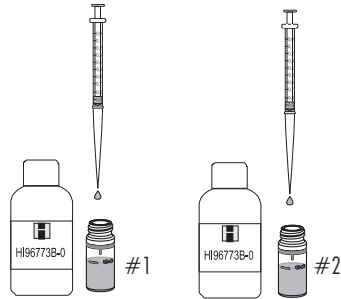

- Replace the caps and invert for 10 seconds.



- Place first cuvette (#1) into the holder and close the lid.

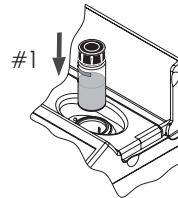

- Press **Timer** and the display will show countdown prior to the measurement or, alternatively, wait for 10 minutes and press **Zero**. The display will show “-0.0-” when the meter is zeroed and ready for measurement.

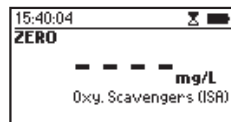
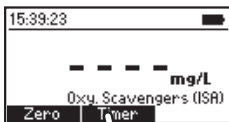

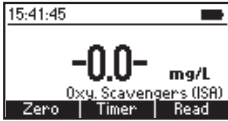

- Remove the cuvette.
- Insert the second cuvette (#2) into the instrument and close the lid.
- Press **Read** to start reading. The instrument displays the results in **mg/L of Iso-ascorbic acid**.

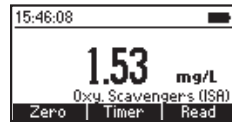
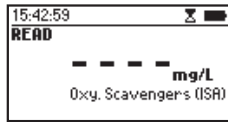
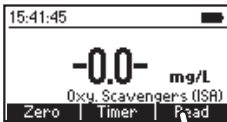
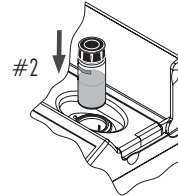

INTERFERENCES

Interference may be caused by:

Borate (as $\text{Na}_2\text{B}_4\text{O}_7$), Cobalt, Copper, Iron (Ferrous), Hardness (as CaCO_3), Light, Lignosulfonates, Manganese, Molybdenum, Nickel, Phosphate, Phosphonates, Sulfate, Temperature, and Zinc.

8.49. OZONE

SPECIFICATIONS

| | |
|--------------|---|
| Range | 0.00 to 2.00 mg/L (as O ₃) |
| Resolution | 0.01 mg/L |
| Accuracy | ±0.02 mg/L ±3% of reading at 25 °C |
| Light Source | LED with narrow band interference filter @ 525 nm |
| Method | Colorimetric DPD Method. |

REQUIRED REAGENTS

| Code | Description | Quantity |
|--------------|-----------------------------------|----------|
| HI93757-0 | Ozone Reagent | 1 packet |
| HI93703-52-0 | Glycine Powder (Optional Reagent) | 1 packet |

REAGENT SETS

| | |
|------------|-----------------------------------|
| HI93757-01 | Reagents for 100 tests |
| HI93757-03 | Reagents for 300 tests |
| HI93703-52 | Reagents for 100 tests (Optional) |

For other accessories see page 200.

Note: If the sample is suspected to contain chlorine residue (free or total chlorine), follow the alternative measurement procedure described below, chlorine is a strong interferent.

- Perform the Standard Measurement Procedure. Record the result as Value A.
- Perform Additional Measurement Procedure. Record the result, Value B.
- To determine the ozone concentration in mg/L subtract Value B from Value A.

$$\text{mg/L ozone (O}_3\text{)} = \text{Value A} - \text{Value B.}$$

STANDARD MEASUREMENT PROCEDURE

- Select the **Ozone** method using the procedure described in the Method Selection section (see page 18).
- Fill the cuvette with 10 mL of unreacted sample (up to the mark) and replace the cap.
- Place the cuvette into the holder and close the lid.

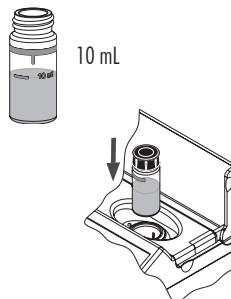

- Press the **Zero** key. The display will show “-0.0-” the meter is zeroed and ready for measurement.

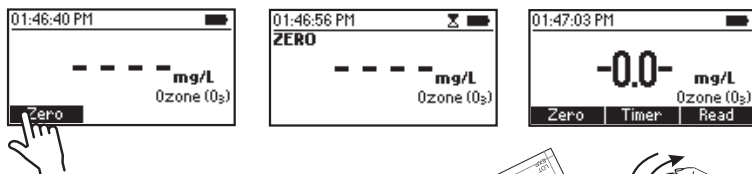

- Remove the cuvette.
- Add one packet of **HI93757-0** Ozone Reagent. Replace the cap and shake gently for 20 seconds.
- Replace the cuvette into the instrument and close the lid.

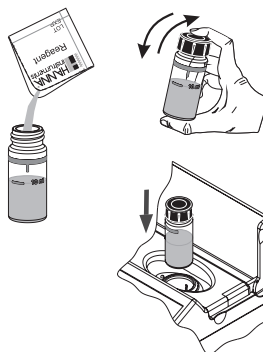

- Press **Timer** and the display will show the countdown prior to the measurement or, alternatively, wait for 2 minutes and press **Read**. When the timer ends the meter will perform the reading. The instrument displays the result in **mg/L ozone (O₃)** (chlorine free sample only).

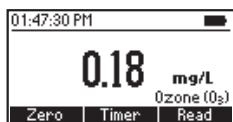

Note: For samples containing chlorine, record this value as A.

ADDITIONAL MEASUREMENT PROCEDURE

For samples containing chlorine

- Fill the cuvette with 10 mL of unreacted sample (up to the mark).
- Place the cuvette into the holder and close the lid.

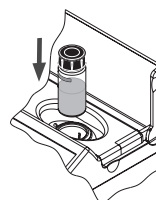

- Press the **Zero** key. The display will show “-0.0-” the meter is zeroed and ready for measure.

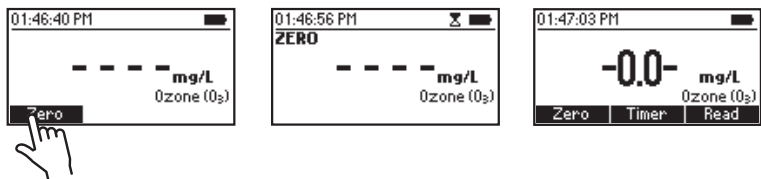

- Remove the cuvette.
- Add one packet of the **HI93703-52-0** Glycine Powder. Replace the cap and shake gently until completely dissolved.

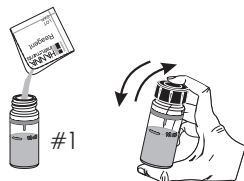

- Add one packet of **HI93757-0** Ozone Reagent. Replace the cap and shake gently for 20 seconds.

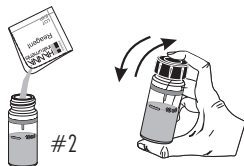

- Replace the cuvette into the instrument and close the lid.

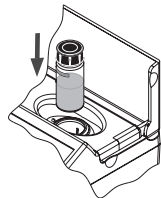

- Press **Timer** and the display will show the countdown prior to the measurement or, alternatively, wait for 2 minutes and press **Read**. When the timer ends the meter will perform the reading. Record this value as B.



- To determine the **mg/L ozone (O₃)** concentration in sample containing chlorine subtract value B (additional measurement procedure) from value A (standard measurement procedure).

INTERFERENCES

Interference may be caused by: Bromine, Chlorine Dioxide, Iodine.

Alkalinity above 250 mg/L CaCO₃ will not reliably develop the full amount of color or it may rapidly fade. To resolve this, neutralize the sample with diluted HCl.

In case of water with hardness greater than 500 mg/L CaCO₃, shake the sample for approximately 2 minutes after adding the powder reagent.

8.50. pH

SPECIFICATIONS

| | |
|--------------|---|
| Range | 6.5 to 8.5 pH |
| Resolution | 0.1 pH |
| Accuracy | ± 0.1 pH at 25 °C |
| Light Source | LED with narrow band interference filter @ 525 nm |
| Method | Adaptation of the Phenol Red method. |

REQUIRED REAGENTS

| Code | Description | Quantity |
|------------|-------------|----------|
| HI 93710-0 | pH Reagent | 5 drops |

REAGENT SETS

HI 93710-01 Reagents for 100 pH tests

HI 93710-03 Reagents for 300 pH tests

For other accessories see page 200.

MEASUREMENT PROCEDURE

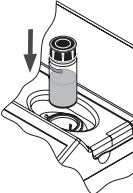
- Select the **pH** method using the procedure described in the Method Selection section (see page 18).
- Fill the cuvette with 10 mL of unreacted sample (up to the mark) and replace the cap.  10 mL
- Place the cuvette into the holder and close the lid. 
- Press the **Zero** key. The display will show “-0.0-” when the meter is zeroed and ready for measurement.

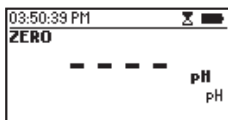
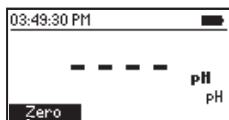

- Remove the cuvette and add 5 drops of **HI93710-0** pH Reagent Indicator. Replace the cap and mix the solution.

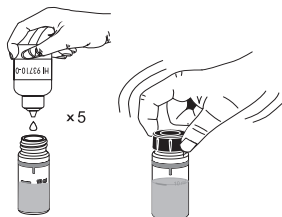

- Reinsert the cuvette into the instrument and close the lid.

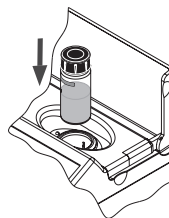

- Press the **Read** key to start the reading. The instrument displays the result in pH.

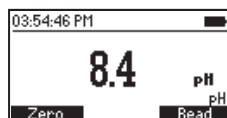
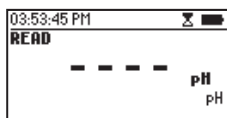

8.51. PHOSPHATE, MARINE ULTRA LOW RANGE

SPECIFICATIONS

| | |
|--------------|---|
| Range | 0 to 200 $\mu\text{g/L}$ (as P) |
| Resolution | 1 $\mu\text{g/L}$ |
| Accuracy | $\pm 5 \mu\text{g/L} \pm 5\%$ of reading at 25 °C |
| Light Source | LED with narrow band interference filter @ 610 nm |
| Method | Adaptation of the Standard Methods for the Examination of Water and Wastewater, 20th edition, Ascorbic Acid method. |

REQUIRED REAGENTS

| Code | Description | Quantity |
|----------|------------------------------------|----------|
| HI736-25 | Phosphorus Ultra Low Range Reagent | 1 packet |

REAGENT SETS

HI736-25 Reagents for 25 tests

For other accessories see page 200.

MEASUREMENT PROCEDURE

- Select the **Phosphate Marine ULR** method using the procedure described in the Method Selection section (see page 18).
- Rinse, cap and shake the cuvette several times with unreacted sample.
- Fill the cuvette with 10 mL of sample (up to the mark) and replace the cap.
- Place the cuvette into the holder and close the lid.
- Press the **Zero** key. The display will show “-0.0-” when the meter is zeroed and ready for measurement.

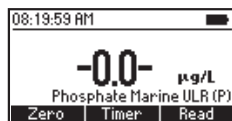
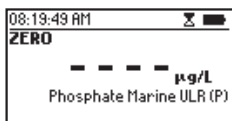
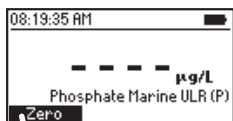
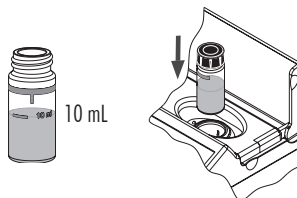

- Add one packet of **HI736-25** Phosphorus Ultra Low Range Reagent. Replace the cap and shake gently (for about 2 minutes) until the powder is completely dissolved.

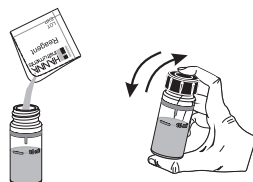

- Reinsert the cuvette into the instrument and close the lid.

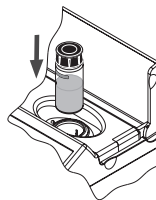

- Press **Timer** and the display will show the countdown prior to the measurement or, alternatively, wait for 3 minutes and press **Read**. When the timer ends the meter will perform the reading. The instrument displays concentration in $\mu\text{g/L}$ of phosphorus (P).

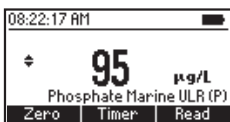
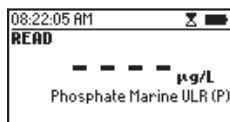
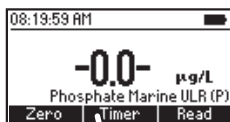

- Press **▲** or **▼** to access the second level functions.
- Press the **Chem Frm** key to convert the result to $\mu\text{g/L}$ of phosphate (PO_4^{3-}) and phosphorus pentoxide (P_2O_5).

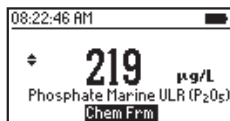
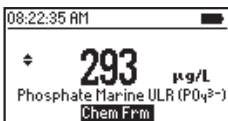
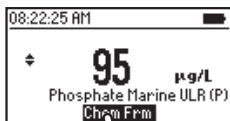

- Press **▲** or **▼** to return to the measurement screen.

INTERFERENCES

Interference may be caused by:

Iron above 50 mg/L

Silica above 50 mg/L

Silicate above 10 mg/L

Copper above 10 mg/L

Hydrogen sulfide, arsenate, turbid sample and highly buffered samples also interfere.

8.52. PHOSPHATE LOW RANGE

SPECIFICATIONS

| | |
|--------------|---|
| Range | 0.00 to 2.50 mg/L (as PO_4^{3-}) |
| Resolution | 0.01 mg/L |
| Accuracy | ± 0.04 mg/L $\pm 4\%$ of reading at 25 °C |
| Light Source | LED with narrow band interference filter @ 610 nm |
| Method | Adaptation of the Ascorbic Acid method. |

REQUIRED REAGENTS

| Code | Description | Quantity |
|-----------|-----------------------------|----------|
| HI93713-0 | Phosphate Low Range Reagent | 1 packet |

REAGENT SETS

HI93713-01 Reagents for 100 tests

HI93713-03 Reagents for 300 tests

For other accessories see page 200.

MEASUREMENT PROCEDURE

- Select the **Phosphate LR** method using the procedure described in the Method Selection section (see page 18).
- Rinse, cap and shake the cuvette several times with unreacted sample.
- Fill the cuvette with 10 mL of sample (up to the mark) and replace the cap.
- Place the cuvette into the holder and close the lid.
- Press the **Zero** key. The display will show “-0.0-” when the meter is zeroed and ready for measurement.

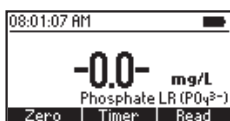
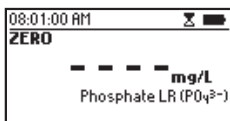
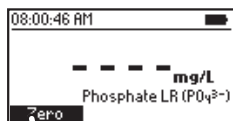
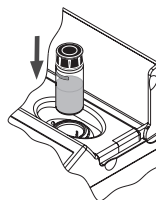

- Remove the cuvette and add the content of one packet of HI93713-0 Phosphate Low Range Reagent. Replace the cap and shake gently (for about 2 minutes) until the powder is completely dissolved.

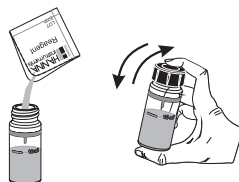

- Reinsert the cuvette into the instrument and close the lid.

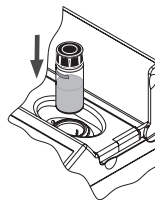

- Press **Timer** and the display will show the countdown prior to the measurement or, alternatively, wait for 3 minutes and press **Read**. When the timer ends the meter will perform the reading. The instrument displays concentration in **mg/L of phosphate (PO_4^{3-})**.

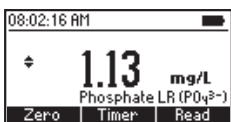
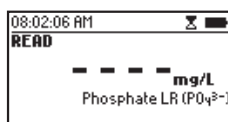
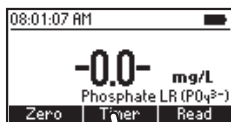

- Press **▲** or **▼** to access the second level functions.
- Press the **Chem Frm** key to convert the result to **mg/L of phosphorus (P) and phosphorus pentoxide (P_2O_5)**.

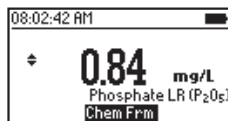
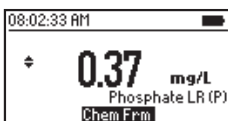
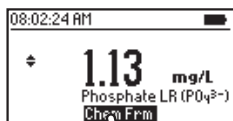

- Press **▲** or **▼** to return to the measurement screen.

INTERFERENCES

Interference may be caused by:

Iron above 50 mg/L

Silica above 50 mg/L

Silicate above 10 mg/L

Copper above 10 mg/L

Hydrogen sulfide, arsenate, turbid sample and highly buffered samples also interfere.

8.53. PHOSPHATE HIGH RANGE

SPECIFICATIONS

| | |
|--------------|--|
| Range | 0.0 to 30.0 mg/L (as PO_4^{3-}) |
| Resolution | 0.1 mg/L |
| Accuracy | ± 1.0 mg/L $\pm 4\%$ of reading at 25 °C |
| Light Source | LED with narrow band interference filter @ 525 nm |
| Method | Adaptation of the Standard Methods for the Examination of Water and Wastewater, 18th edition, Amino Acid method. |

REQUIRED REAGENTS

| Code | Description | Quantity |
|------------|--------------------------------|----------|
| HI93717A-0 | Phosphate High Range Reagent A | 10 drops |
| HI93717B-0 | Phosphate High Range Reagent B | 1 packet |

REAGENT SETS

| | |
|------------|------------------------|
| HI93717-01 | Reagents for 100 tests |
| HI93717-03 | Reagents for 300 tests |

For other accessories see page 200.

MEASUREMENT PROCEDURE

- Select the **Phosphate HR** method using the procedure described in the Method Selection section (see page 18).
- Fill the cuvette with 10 mL of unreacted sample (up to the mark) and replace the cap.
- Place the cuvette into the holder and close the lid.
- Press the **Zero** key. The display will show “-0.0-” when the meter is zeroed and ready for measurement.

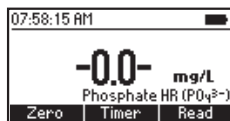
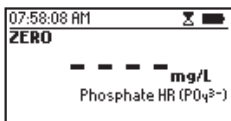
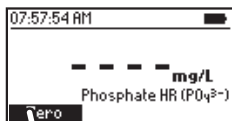
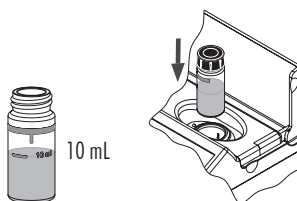

- Add 10 drops of **HI93717A-0** Phosphate High Range Reagent A.

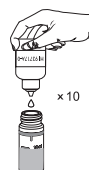

- Add one packet of **HI93717B-0** Phosphate HR Reagent B to the cuvette. Replace the cap and shake gently until completely dissolved.

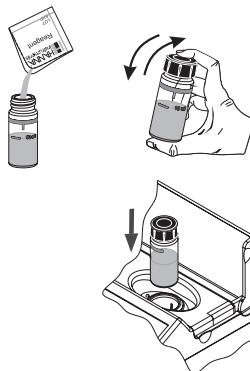

- Reinsert the cuvette into the instrument and close the lid.

- Press **Timer** and the display will show the countdown prior to the measurement or, alternatively, wait for 5 minutes and press **Read**. When the timer ends the meter will perform the reading. The instrument displays the results in **mg/L of phosphate (PO_4^{3-})**.

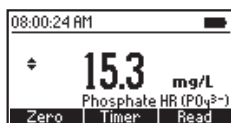
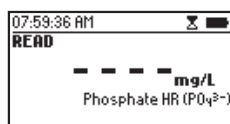
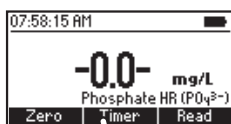

- Press **▲** or **▼** to access the second level functions.
- Press the **Chem Frm** key to convert the result to **mg/L of phosphorus (P)** and **phosphorus pentoxide (P_2O_5)**.

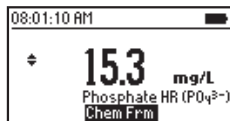
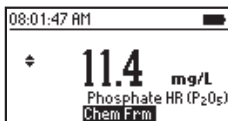
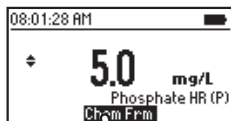

- Press **▲** or **▼** to return to the measurement screen.

INTERFERENCES

Sulfide

Chloride above 150000 mg/L

Calcium above 10000 mg/L as CaCO_3

Magnesium above 40000 mg/L as CaCO_3

Ferrous iron above 100 mg/L

8.54. POTASSIUM

SPECIFICATIONS

| | |
|--------------|---|
| Range | 0.0 to 20.0 mg/L (as K) |
| Resolution | 0.1 mg/L |
| Accuracy | ± 3.0 mg/L $\pm 7\%$ of reading at 25 °C |
| Light Source | LED with narrow band interference filter @ 466 nm |
| Method | Adaptation of the Turbidimetric Tetraphenylborate method. |

REQUIRED REAGENTS

| Code | Description | Quantity |
|------------|---------------------|----------|
| HI93750A-0 | Potassium Reagent A | 6 drops |
| HI93750B-0 | Potassium Reagent B | 1 packet |

REAGENT SETS

HI93750-01 Reagents for 100 tests

HI93750-03 Reagents for 300 tests

For other accessories see page 200.

MEASUREMENT PROCEDURE

- Select the **Potassium** method using the procedure described in the Method Selection section (see page 18).

- Fill the cuvette with 10 mL of sample (up to the mark).



- Add 6 drops of **HI93750A-0** Potassium Reagent A. Replace the cap and swirl the solution.

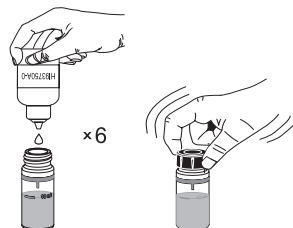

- Place the cuvette into the holder and close the lid.

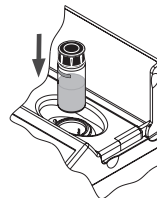

- Press the **Zero** key. The display will show “-0.0-” when the meter is zeroed and ready for measurement.

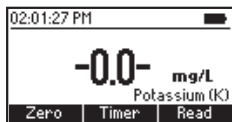
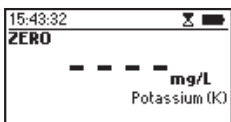
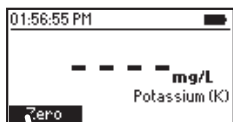

- Add one packet of **HI93750B-0** Potassium Reagent B. Replace the cap and shake gently for 1 minute.



- Reinsert the cuvette into the instrument and close the lid.

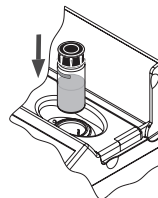

- Press **Timer** and the display will show the countdown prior to the measurement or, alternatively, wait for 2 minutes and press **Read**. When the timer ends the meter will perform the reading. The instrument displays the results in **mg/L of potassium (K)**.

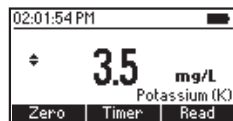
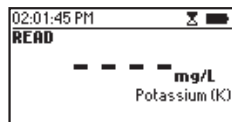

- Press **▲** or **▼** to access the second level functions.

- Press the **Chem Frm** key to convert the result to mg/L of potassium oxide (K_2O).

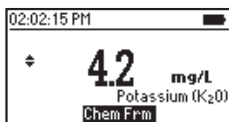
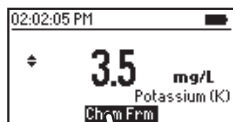

- Press ▲ or ▼ to return to the measurement screen.

INTERFERENCES

Interferences may be caused by:

Ammonium above 10 ppm

Calcium above 10000 ppm as $CaCO_3$

Chloride above 12000 ppm

Magnesium above 8000 ppm as $CaCO_3$

Sodium above 8000 ppm

8.55. SILICA LOW RANGE

SPECIFICATIONS

| | |
|--------------|---|
| Range | 0.00 to 2.00 mg/L (as SiO ₂) |
| Resolution | 0.01 mg/L |
| Accuracy | ±0.03 mg/L ±3% of reading at 25 °C |
| Light Source | LED with narrow band interference filter @ 610 nm |
| Method | Adaptation of the ASTM Manual of Water and Environmental Technology, D859, Heteropoly Molybdenum Blue method. |

REQUIRED REAGENTS

| Code | Description | Quantity |
|------------|----------------------------|----------|
| HI93705A-0 | Silica Low Range Reagent A | 6 drops |
| HI93705B-0 | Silica Low Range Reagent B | 1 packet |
| HI93705C-0 | Silica Low Range Reagent C | 1 packet |

REAGENT SETS

HI93705-01 Reagents for 100 tests

HI93705-03 Reagents for 300 tests

For other accessories see page 200.

MEASUREMENT PROCEDURE

- Select the **Silica LR** method using the procedure described in the Method Selection section (see page 18).
- Fill the cuvette with 10 mL of unreacted sample (up to the mark).
- Add 6 drops of **HI93705A-0** Silica Low Range Reagent A. Replace the cap and swirl the solution.
- Press **Timer** and the display will show the countdown prior to adding **HI93705B-0** Silica Low Range Reagent B, or alternatively wait 4 minutes.
- Add one packet of **HI93705B-0** Silica Low Range Reagent B and shake until it is completely dissolved.
- Press **Continue** and the display will show the countdown, or alternatively wait 1 minute.

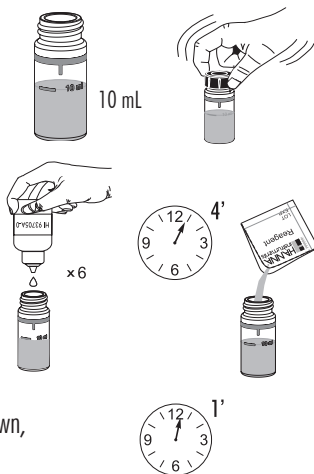

- Place the cuvette into the holder and close the lid.

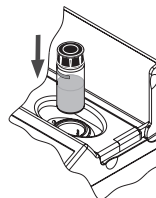

- Press the **Zero** key. The display will show “-0.0-” when the meter is zeroed and ready for measurement.

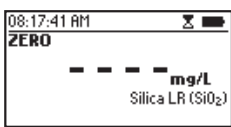
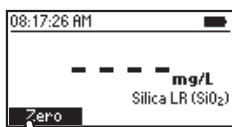

- Remove the cuvette.
- Add one packet of **HI93705C-0** Silica Low Range Reagent C and shake until it is completely dissolved.

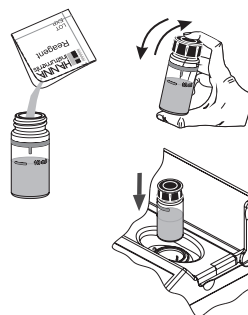

- Reinsert the cuvette into the instrument and close the lid.

- Press **Timer** and the display will show the countdown prior to the measurement, or alternatively, wait 3 minutes and press **Read**. When the timer ends the meter will perform the reading. The instrument displays result in **mg/L of silica (SiO₂)**.

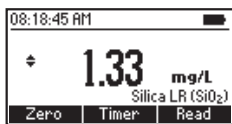
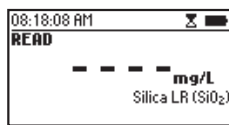

- Press **▲** or **▼** to access the second level functions.

- Press the **Chem Frm** key to convert the result to mg/L of silicon (Si).

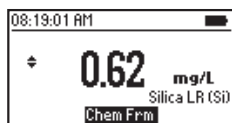

- Press ▲ or ▼ to return to the measurement screen.

INTERFERENCES

Interference may be caused by:

Phosphate above 60 mg/L (causes a 2% reduction in reading)

Phosphate above 75 mg/L (causes an 11% reduction in reading)

Sulfide and high concentration of iron

Eliminate color and turbidity interferences by zeroing the meter with the original water sample.

8.56. SILICA HIGH RANGE

SPECIFICATIONS

| | |
|--------------|--|
| Range | 0 to 200 mg/L (as SiO ₂) |
| Resolution | 1 mg/L |
| Accuracy | ± 1 mg/L ± 5% of reading at 25 °C |
| Light Source | LED with narrow band interference filter @ 466 nm |
| Method | Adaptation of the USEPA Method 370.1 for drinking, surface and saline waters, domestic and industrial wastes and Standard Method 4500-SiO ₂ . |

REQUIRED REAGENTS

| Code | Description | Quantity |
|------------|-----------------------------|----------|
| HI96770A-0 | Silica High Range Reagent A | 1 packet |
| HI96770B-0 | Silica High Range Reagent B | 1 packet |
| HI96770C-0 | Silica High Range Reagent C | 1 packet |

REAGENT SETS

HI96770-01 Reagents for 100 tests

HI96770-03 Reagents for 300 tests

For other accessories see page 200.

MEASUREMENT PROCEDURE

- Select the **Silica HR** method using the procedure described in the Method Selection section (see page 18).
- Fill the cuvette with 10 mL of unreacted sample (up to the mark) and replace the cap.
- Place the cuvette into the holder and close the lid.
- Press the **Zero** key. The display will show “-0.0-” when the meter is zeroed and ready for measurement.

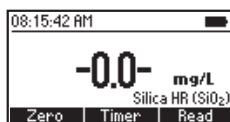
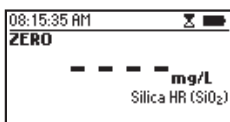
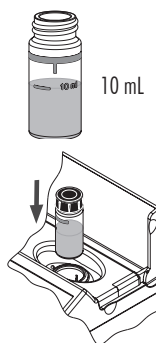

- Remove the cuvette.
- Add one packet of **HI96770A-0** Silica High Range Reagent A and shake vigorously until completely dissolved.

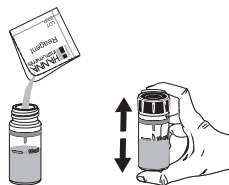

- Add one packet of **HI96770B-0** Silica High Range Reagent B. Replace the cap and shake vigorously until completely dissolved.

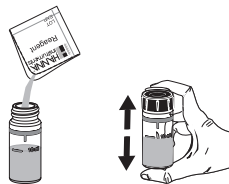

- Press **Timer** and the display will show the countdown prior adding **HI96770C-0** Silica High Range Reagent C, or alternatively wait 10 minutes.



- Add one packet of **HI96770C-0** Silica High Range Reagent C and shake vigorously until completely dissolved.

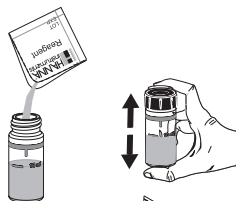

- Reinsert the cuvette into the instrument and close the lid.

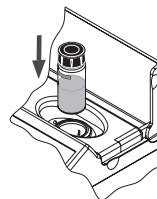

- Press **Continue** and the display will show the countdown prior to the measurement, or alternatively wait 2 minutes and press **Read**. When the timer ends the meter will perform the reading. The instrument displays the results in **mg/L silica (SiO₂)**.

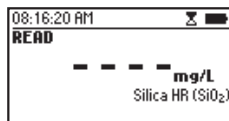



- Press ▲ or ▼ to access the second level functions.
- Press the **Chem Frm** key to convert the result to mg/L of silicon (Si).

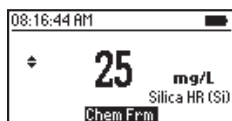
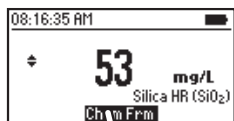

- Press ▲ or ▼ to return to the measurement screen.

INTERFERENCES

Interference may be caused by:

Phosphate above 60 mg/L (causes a 2% reduction in reading)

Phosphate above 75 mg/L (causes an 11% reduction in reading)

Sulfide and high concentration of iron

Eliminate color and turbidity interferences by zeroing the meter with the original water sample.

8.57. SILVER

SPECIFICATIONS

| | |
|--------------|--|
| Range | 0.000 to 1.000 mg/L (as Ag) |
| Resolution | 0.001 mg/L |
| Accuracy | ± 0.020 mg/L $\pm 5\%$ of reading at 25 °C |
| Light Source | LED with narrow band interference filter @ 575 nm. |
| Method | Adaptation of the PAN method. |

REQUIRED REAGENTS

| Code | Description | Quantity |
|------------|------------------|----------|
| HI93737A-0 | Silver Reagent A | 1 mL |
| HI93737B-0 | Silver Reagent B | 1 mL |
| HI93737C-0 | Silver Reagent C | 2 mL |
| HI93737D-0 | Silver Reagent D | 2 mL |
| HI93703-51 | Dispersing Agent | 6 drops |

REAGENT SETS

| | |
|------------|------------------------|
| HI93737-01 | Reagents for 50 tests |
| HI93737-03 | Reagents for 150 tests |

For other accessories see page 200.

MEASUREMENT PROCEDURE

- Select the **Silver** method using the procedure described in the Method Selection section (see page 18).

Note: For best results perform your tests between 20-24 °C.

- Fill two graduated beakers with 25 mL of sample.

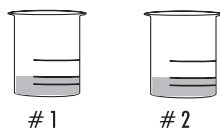

- Add 1 mL of **HI93737A-0** Silver Reagent A to beaker #1 (the blank) and swirl gently to mix.

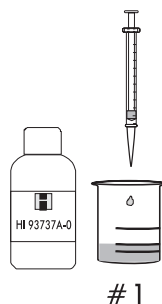

- Add 1 mL of **HI93737B-0** Silver Reagent B to beaker #2 (the sample) and swirl gently to mix.

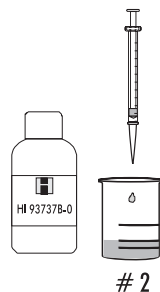

- Press **Timer** and the display will show the countdown prior to adding **HI93737C-0** Silver Reagent C or alternatively, wait for 2 minutes.

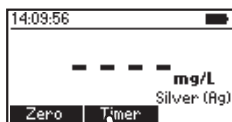

- Add 1 mL of **HI93737C-0** Silver Reagent C to each beaker and swirl.

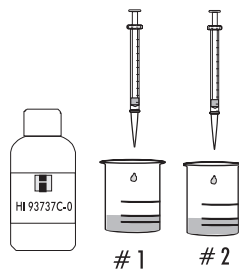

- Press **Continue** and the display will show the countdown prior to adding **HI93737D-0** Silver Reagent D, or alternatively, wait for 2 minutes.



- Add 1 mL of **HI93737D-0** Silver Reagent D to each beaker and swirl.

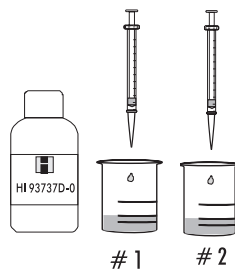

- Press **Continue** and the display will show the countdown or alternatively wait for 2 minutes.

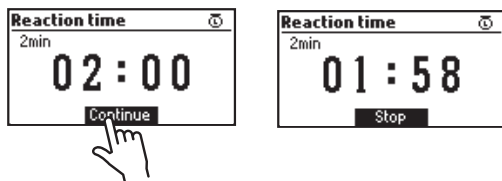

- Fill cuvette (#1) up with 10 mL of the blank (up to the mark).

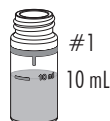

- Add 3 drops of **HI93703-51** Dispersing Agent, replace the cap and invert gently for 10 seconds.

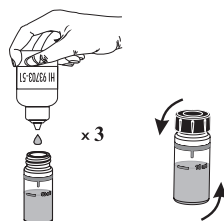

- Place the cuvette into the holder and close the lid.

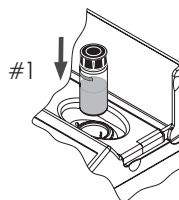

- Press the **Zero** key. The display will show “-0.0-” when the meter is zeroed and ready for measurement.

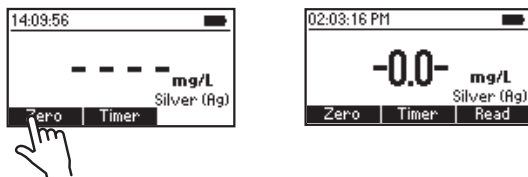

- Fill a second cuvette (#2) up with 10 mL of the reacted sample (up to the mark).

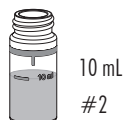

- Add 3 drops of **HI93703-51** Dispersing Agent, replace the cap and invert gently for 10 seconds.

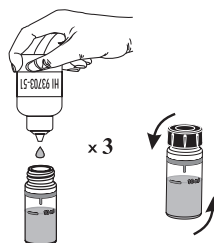

- Insert the second cuvette (#2) into the instrument.

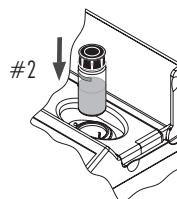

- Press **Read** to start the reading. The instrument displays the results in **mg/L of silver (Ag)**.

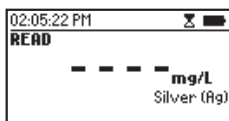
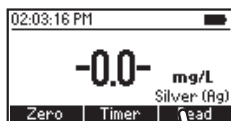

INTERFERENCES

Interference may be caused by:

Al^{3+} above 30 mg/L

Ca^{2+} above 1000 mg/L (as CaCO_3)

Cd^{2+} above 20 mg/L

Cl^- above 8000 mg/L

Co^{2+} above 1.5 mg/L

Cr^{3+} above 20 mg/L

Cr^{6+} above 40 mg/L

Cu^{2+} above 15 mg/L

F^- above 20 mg/L

Fe^{2+} above 1.5 mg/L

Fe_3^+ above 10 mg/L

K^+ above 500 mg/L

Mn^{2+} above 25 mg/L

Mg^{2+} above 1000 mg/L (as CaCO_3)

Na^+ above 5000 mg/L

Ni^{2+} above 1.5 mg/L

Pb^{2+} above 20 mg/L

Zn^{2+} above 30 mg/L

8.58. SULFATE

SPECIFICATIONS

| | |
|--------------|--|
| Range | 0 to 150 mg/L (as SO_4^{2-}) |
| Resolution | 1 mg/L |
| Accuracy | $\pm 5 \text{ mg/L} \pm 3\%$ of reading at 25 °C |
| Light Source | LED with narrow band interference filter @ 466 nm |
| Method | Sulfate is precipitated with barium chloride crystals. |

REQUIRED REAGENTS

| Code | Description | Quantity |
|-----------|-----------------|----------|
| HI93751-0 | Sulfate Reagent | 1 packet |

REAGENT SETS

HI93751-01 Reagents for 100 tests

HI93751-03 Reagents for 300 tests

For other accessories see page 200.

MEASUREMENT PROCEDURE

- Select the **Sulfate** method using the procedure described in the Method Selection section (see page 18).
- Fill a cuvette with 10 mL of unreacted sample (up to the mark) and replace the cap.
- Place the cuvette into the holder and close the lid.
- Press the **Zero** key. The display will show “-0.0-” when the meter is zeroed and ready for measurement.

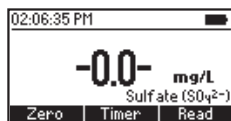
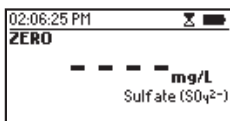
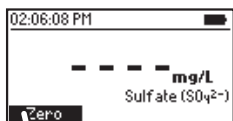
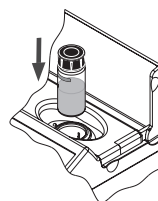

- Add one packet of **HI93751-0** Sulfate Reagent.
- Replace the cap and invert gently for 1 minute (about 30 inversions).
- Reinsert the cuvette into the instrument and close the lid.

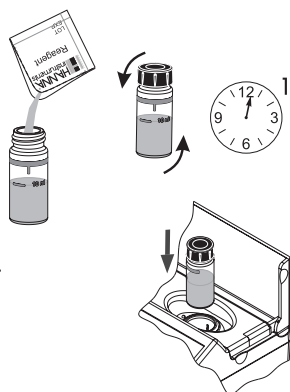

- Press **Timer** and the display will show the countdown prior to the measurement or, alternatively, wait for 5 minutes and press **Read**. When the timer ends the meter will perform the reading. The instrument displays the concentration in **mg/L of sulfate (SO_4^{2-})**.

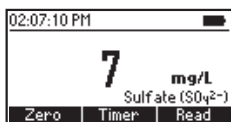
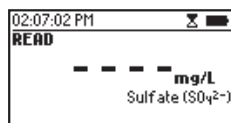
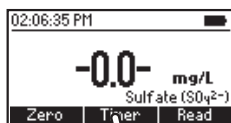

INTERFERENCES

Interferences may be caused by:

Calcium (as CaCO_3) above 20000 mg/L

Chloride (as Cl^-) above 40000 mg/L

Magnesium (as MgCO_3) above 10000 mg/L

Silica (as SiO_2) above 500 mg/L

Color or suspended matter in large amounts will interfere: suspended matter should be removed by previous filtration.

Organic matter in large amounts may impede the precipitation of barium sulfate.

8.59. SURFACTANTS, ANIONIC

SPECIFICATIONS

| | |
|--------------|--|
| Range | 0.00 to 3.50 mg/L (as SDBS) |
| Resolution | 0.01 mg/L |
| Accuracy | ± 0.04 mg/L $\pm 3\%$ of reading at 25 °C |
| Light Source | LED with narrow band interference filter @ 610 nm |
| Method | Adaptation of the USEPA method 425.1 and Standard Methods for the Examination of Water and Wastewater, 20th edition, 5540C, Anionic Surfactants as MBAS. |

REQUIRED REAGENTS

| Code | Description | Quantity |
|--------------|-------------------------------|----------|
| HI95769A-0 | Anionic Surfactants Reagent A | 4 drops |
| HI95769B-0 | Anionic Surfactants Reagent B | 2 drops |
| - | Chloroform Reagent | 10 mL |
| DEIONIZED120 | Deionize Water | 15 mL |

REAGENT SETS

HI95769-01 Reagents for 40 tests

For other accessories see page 200.

MEASUREMENT PROCEDURE

- Select the **Surfactants (Anionic)** method using the procedure described in the Method Selection section (see page 18).

- Fill the graduated glass vial with 25 mL of sample.

Note: For improved accuracy the use of class A laboratory pipettes is recommended.

- Add 2 drops of HI95769A-0 Anionic Surfactants Reagent A and 2 drops of HI95769B-0 Anionic Surfactants Reagent B.

- Close vial with its cap and invert to mix, the solution will turn blue.

- Add 10 mL of Chloroform.

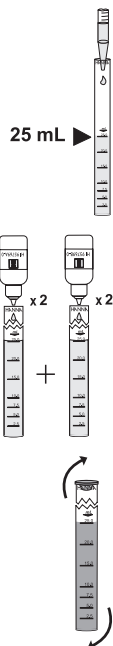

Note: Chloroform is more dense than water will sink to the bottom of the graduated glass vial.

- Invert the vial twice and remove the cap to release any pressure that has built up.
- Close the glass vial with its cap and shake it vigorously for 30 seconds.

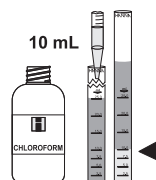

Note: Ensure the cap is secure when shaking.

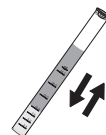

- Press **Timer** and the display will show the countdown or, alternatively, wait for 2 minutes. During this period the chloroform layer separates from the aqueous layer, the color of the aqueous layer will fade slightly, while the chloroform layer will turn blue.

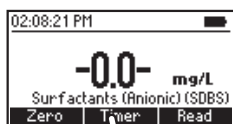

- Remove the cap.
- Remove the upper aqueous layer using the long plastic pipette, do not remove the lower chloroform layer.
- Add 15 mL of deionized water to the vial (up to the 25 mL mark).
- Add 2 drops of **HI95769A-0** Anionic Surfactants Reagent A.



- Invert the vial twice and remove the cap to release any pressure that has built up.

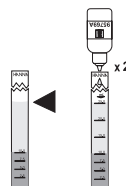

- Close the glass vial with its cap and shake it vigorously for 30 seconds.

Note: Ensure the cap is secure when shaking.

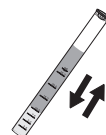

- Press **Continue** and the display will show the countdown, or alternatively, wait for 2 minutes. During this period, the chloroform layer separates from the aqueous layer.



- Remove the cap.
- Insert a clean plastic pipette below the upper aqueous layer to transfer the lower chloroform layer into a cuvette. Do not transfer any of the upper aqueous layer.

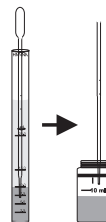

Notes: The solution in the cuvette must be clear. If the solution is cloudy, the separation between the chloroform and aqueous layer can be improved by gently warming the cuvette (holding the vial in your hand). If the chloroform layer contains some aqueous drops hanging on the cuvette wall, gently swirl or invert the cuvette.

It is important to transfer at least 7 mL of chloroform layer into the measurement cuvette, thus up to 0.5 cm (1/4") below the 10 mL mark. If the transferred volume is lower than 7 mL, the accuracy of the test may be affected. Please repeat the test waiting for longer than 2 minutes to allow complete separation between the two phases.

- Cap the cuvette. This is the reacted sample (#2).



- Fill another cuvette with 10 mL of Chloroform reagent (up to the mark) and place the cap. This is the blank (#1).



- Place the blank cuvette (#1) into the holder and close the lid.

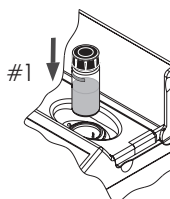

- Press **Zero** the display, depending on the measurement phase. After a few seconds, the display will show “-0.0-” when the meter is zeroed and ready for measurement.

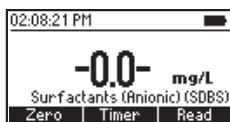
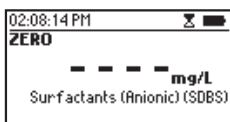
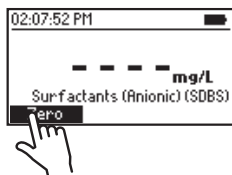

- Remove the cuvette.
- Place the reacted sample (#2) into the instrument and close the lid.

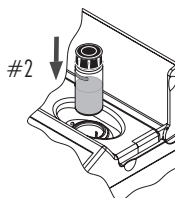

- Press **Read** key to start the reading. The instrument displays the result in **mg/L as SDBS**.

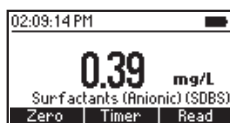
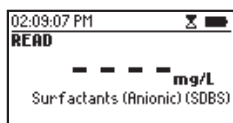
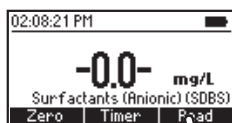

INTERFERENCES

Cationic surfactants negative interference

Absorption particulate matter negative interference

Sulfide negative interference

Organic sulfates, sulfonates positive interference

Strong oxidants (Cl_2 , H_2O_2 , $\text{S}_2\text{O}_8^{2-}$, etc.) negative interference

Highly buffered samples or with extreme pH may exceed the buffering capacity of the reagent: pH should be adjusted between 4 and 9 with diluted NaOH for acidic samples or with diluted HCl for alkaline samples, prior to addition of the reagent.

8.60. ZINC

SPECIFICATIONS

| | |
|--------------|--|
| Range | 0.00 to 3.00 mg/L (as Zn) |
| Resolution | 0.01 mg/L |
| Accuracy | ± 0.03 mg/L $\pm 3\%$ of reading at 25 °C |
| Light Source | LED with narrow band interference filter @ 575 nm |
| Method | Adaptation of the Standard Methods for the Examination of Water and Wastewater, 18th edition, Zincon method. |

REQUIRED REAGENT

| Code | Description | Quantity |
|------------|----------------|----------|
| HI93731A-0 | Zinc Reagent A | 1 packet |
| HI93731B-0 | Zinc Reagent B | 0.5 mL |

REAGENT SETS

| | |
|------------|------------------------|
| HI93731-01 | Reagents for 100 tests |
| HI93731-03 | Reagents for 300 tests |

For other accessories see page 200.

MEASUREMENT PROCEDURE

- Select the **Zinc** method using the procedure described in the Method Selection section (see page 18).
- Fill the graduated glass vial up to the 20 mL mark with the sample.
- Add one packet of **HI93731A-0** Zinc Reagent A, close the cylinder, and invert several times to mix until completely dissolved.
- Fill a cuvette with 10 mL of the reacted sample (up to the mark) and close the cap.

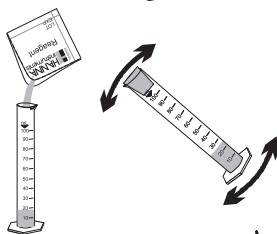
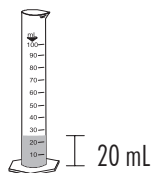

- Place the cuvette into the holder and close the lid.

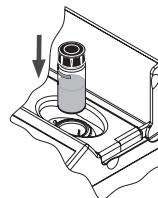

- Press the **Zero** key. The display will show “-0.0-” when the meter is zeroed and ready for measurement.

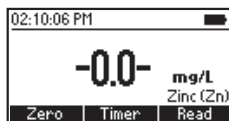
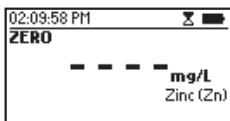
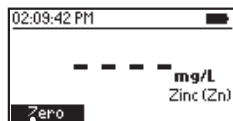

- Add 0.5 mL of **HI93731B-0** Zinc Reagent B to the cuvette, close the cuvette with the supplied HDPE plastic stopper to prevent contamination.
- Replace the cap and mix for 15 seconds.

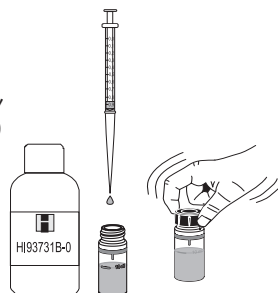

- Insert the sample into the instrument and close the lid.

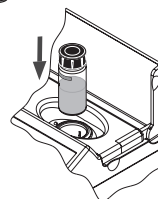

- Press **Timer** and the display will show the countdown prior to the measurement or, alternatively, wait for 3 minutes and 30 seconds and press **Read**. When the timer ends the meter will perform the reading. The instrument displays the results in **mg/L of zinc (Zn)**.

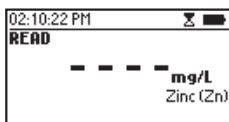
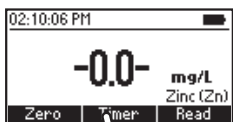

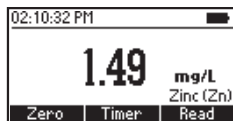

INTERFERENCES

Interference may be caused by:

Aluminum above 6 mg/L Iron above 7 mg/L

Cadmium above 0.5 mg/L Manganese above 5 mg/L

Copper above 5 mg/L Nickel above 5 mg/L

9. ERROR DESCRIPTIONS

The instrument shows clear warning messages when erroneous conditions appear and when measured values are outside the expected range. These messages are described below.

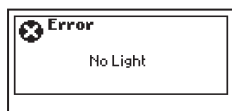

No Light: The light source is not functioning properly.



Light Leak: There is an excess amount of ambient light reaching the detector.



Inverted Cuvette: The sample and the zero cuvettes are inverted.



Light Low: The instrument cannot adjust the light level. Please check that the sample does not contain any debris.

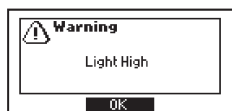

Light High: There is too much light to perform a measurement. Please check the preparation of the zero cuvette.



Ambient temperature out of limit: The meter is too hot or too cold for an accurate measurement. Allow the meter to reach 10 °C to 40 °C (50 °F to 104 °F) before performing a measurement.



Ambient temperature changed: The temperature of the meter has changed significantly since the zero measurement has been performed. A zero measurement must be performed again.

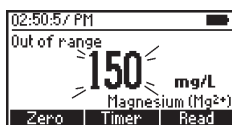

Out of range: The measured value is outside the limits of the method.

10. STANDARD METHODS

| Description | Range | Method |
|---------------------|---------------------|------------------------------|
| Alkalinity | 0 to 500 mg/L | Colorimetric |
| Alkalinity, Marine | 0 to 300 mg/L | Colorimetric |
| Aluminum | 0.00 to 1.00 mg/L | Aluminon |
| Ammonia LR | 0.00 to 3.00 mg/L | Nessler |
| Ammonia MR | 0.00 to 10.00 mg/L | Nessler |
| Ammonia HR | 0.0 to 100.0 mg/L | Nessler |
| Bromine | 0.00 to 8.00 mg/L | DPD |
| Calcium | 0 to 400 mg/L | Oxalate |
| Calcium Marine | 200 to 600 mg/L | Zincon |
| Chloride | 0.0 to 20.0 mg/L | Mercury(II) Thiocyanate |
| Chlorine Dioxide | 0.00 to 2.00 mg/L | Chlorophenol Red |
| Chlorine, Free LR | 0.00 to 5.00 mg/L | DPD |
| Chlorine, Free ULR | 0.000 to 0.500 mg/L | DPD |
| Chlorine, Total LR | 0.00 to 5.00 mg/L | DPD |
| Chlorine, Total ULR | 0.000 to 0.500 mg/L | DPD |
| Chlorine, Total UHR | 0 to 500 mg/L | Standard Methods 4500-Cl |
| Chromium (VI) LR | 0 to 300 μ g/L | Diphenylcarbohydrazide |
| Chromium (VI) HR | 0 to 1000 μ g/L | Diphenylcarbohydrazide |
| Color of Water | 0 to 500 PCU | Colorimetric Platinum Cobalt |
| Copper LR | 0.000 to 1.500 mg/L | Bicinchoninate |
| Copper HR | 0.00 to 5.00 mg/L | Bicinchoninate |
| Cyanuric Acid | 0 to 80 mg/L | Turbidimetric |
| Fluoride LR | 0.00 to 2.00 mg/L | SPADNS |
| Fluoride HR | 0.0 to 20.0 mg/L | SPADNS |
| Hardness, Calcium | 0.00 to 2.70 mg/L | Calmagite |
| Hardness, Magnesium | 0.00 to 2.00 mg/L | EDTA |

| Description | Range | Method |
|---------------------------------------|---------------------|-----------------------------|
| Hardness, Total LR | 0 to 250 mg/L | EPA 130.1 |
| Hardness, Total MR | 200 to 500 mg/L | EPA 130.1 |
| Hardness, Total HR | 400 to 750 mg/L | EPA 130.1 |
| Hydrazine | 0 to 400 μ g/L | p-Dimethylaminobenzaldehyde |
| Iodine | 0.0 to 12.5 mg/L | DPD |
| Iron LR | 0.000 to 1.600 mg/L | TPTZ |
| Iron HR | 0.00 to 5.00 mg/L | Phenanthroline |
| Magnesium | 0 to 150 mg/L | Calmagite |
| Manganese LR | 0 to 300 μ g/L | PAN |
| Manganese HR | 0.0 to 20.0 mg/L | Periodate |
| Molybdenum | 0.0 to 40.0 mg/L | Mercaptoacetic Acid |
| Nickel LR | 0.000 to 1.000 mg/L | PAN |
| Nickel HR | 0.00 to 7.00 g/L | Colorimetric |
| Nitrate | 0.0 to 30.0 mg/L | Cadmium reduction |
| Nitrite, Marine ULR | 0 to 200 μ g/L | Diazotization |
| Nitrite LR | 0 to 600 μ g/L | Diazotization |
| Nitrite HR | 0 to 150 mg/L | Ferrous Sulfate |
| Oxygen, Dissolved | 0.0 to 10.0 mg/L | Winkler |
| Oxygen Scavengers (Carbohydrazide) | 0.00-1.50mg/L | Iron Reduction |
| Oxygen Scavengers (DEHA) | 0 to 1000 μ g/L | Iron Reduction |
| Oxygen Scavengers (Hydroquinone) | 0.00-2.50mg/L | Iron Reduction |
| Oxygen Scavengers (Iso-Ascorbic Acid) | 0.00-4.50mg/L | Iron Reduction |
| Ozone | 0.00 to 2.00 mg/L | DPD |
| pH | 6.5 to 8.5 pH | Phenol Red |
| Phosphate, Marine ULR | 0 to 200 μ g/L | Ascorbic Acid |
| Phosphate LR | 0.00 to 2.50 mg/L | Ascorbic Acid |
| Phosphate HR | 0.0 to 30.0 mg/L | Amino Acid |

| Description | Range | Method |
|----------------------|---------------------|-------------------|
| Potassium | 0.0 to 20.0 mg/L | Tetraphenylborate |
| Silica LR | 0.00 to 2.00 mg/L | Heteropoly Blue |
| Silica HR | 0 to 200 mg/L | EPA |
| Silver | 0.000 to 1.000 mg/L | PAN |
| Sulfate | 0 to 150 mg/L | Barium Chloride |
| Surfactants, Anionic | 0.00 to 3.50 mg/L | EPA 425.1 |
| Zinc | 0.00 to 3.00 mg/L | Zincon |

11. ACCESSORIES

11.1. REAGENT SETS

| Code | Description |
|------------|-----------------------------------|
| HI736-25 | 25 phosphate marine ULR tests |
| HI755-26 | 25 alkalinity marine tests |
| HI758-26 | 25 calcium marine tests |
| HI764-25 | 25 nitrite marine ULR tests |
| HI775-26 | 25 alkalinity fresh water tests |
| HI93700-01 | 100 ammonia LR tests |
| HI93700-03 | 300 ammonia LR tests |
| HI93701-01 | 100 chlorine free tests (powder) |
| HI93701-03 | 300 chlorine free tests (powder) |
| HI93701-F | 300 chlorine free tests (liquid) |
| HI93701-T | 300 chlorine total tests (liquid) |
| HI93702-01 | 100 copper HR tests |
| HI93702-03 | 300 copper HR tests |
| HI93703-52 | 100 ozone tests |
| HI93704-01 | 100 hydrazine tests |
| HI93704-03 | 300 hydrazine tests |
| HI93705-01 | 100 silica LR tests |
| HI93705-03 | 300 silica LR tests |
| HI93707-01 | 100 nitrite LR tests |
| HI93707-03 | 300 nitrite LR tests |
| HI93708-01 | 100 nitrite HR tests |
| HI93708-03 | 300 nitrite HR tests |
| HI93709-01 | 100 manganese HR tests |
| HI93709-03 | 300 manganese HR tests |
| HI93710-01 | 100 pH tests |
| HI93710-03 | 300 pH tests |
| HI93711-01 | 100 chlorine total tests (powder) |
| HI93711-03 | 300 chlorine total tests (powder) |
| HI93712-01 | 100 aluminum tests |
| HI93712-03 | 300 aluminum tests |
| HI93713-01 | 100 phosphate LR tests |
| HI93713-03 | 300 phosphate LR tests |
| HI93715-01 | 100 ammonia MR tests |

| Code | Description |
|------------|---|
| HI93715-03 | 300 ammonia MR tests |
| HI93716-01 | 100 bromine tests |
| HI93716-03 | 300 bromine tests |
| HI93717-01 | 100 phosphate HR tests |
| HI93717-03 | 300 phosphate HR tests |
| HI93718-01 | 100 iodine tests |
| HI93718-03 | 300 iodine tests |
| HI93719-01 | 100 hardness magnesium tests |
| HI93719-03 | 300 hardness magnesium tests |
| HI93720-01 | 100 hardness calcium tests |
| HI93720-03 | 300 hardness calcium tests |
| HI93721-01 | 100 iron HR tests |
| HI93721-03 | 300 iron HR tests |
| HI93722-01 | 100 cyanuric acid tests |
| HI93722-03 | 300 cyanuric acid tests |
| HI93723-01 | 100 chromium (VI) HR tests |
| HI93723-03 | 300 chromium (VI) HR tests |
| HI93726-01 | 100 nickel HR tests |
| HI93726-03 | 300 nickel HR tests |
| HI93728-01 | 100 nitrate tests |
| HI93728-03 | 300 nitrate tests |
| HI93729-01 | 100 fluoride LR tests |
| HI93729-03 | 300 fluoride LR tests |
| HI93730-01 | 100 molybdenum tests |
| HI93730-03 | 300 molybdenum tests |
| HI93732-01 | 100 dissolved oxygen tests |
| HI93732-03 | 300 dissolved oxygen tests |
| HI93731-01 | 100 zinc tests |
| HI93731-03 | 300 zinc tests |
| HI93733-01 | 100 ammonia HR tests |
| HI93733-03 | 300 ammonia HR tests |
| HI93735-01 | 100 hardness total MR tests (200 to 500 mg/L) |
| HI93735-02 | 100 hardness total HR tests (400 to 750 mg/L) |
| HI93735-0 | 300 hardness total tests (LR - 100 tests, MR - 100 tests, HR - 100 tests) |
| HI93735-00 | 100 hardness total LR tests (0 to 250 mg/L) |

| Code | Description |
|-------------|-------------------------------|
| HI93737-01 | 50 silver tests |
| HI93737-03 | 150 silver tests |
| HI93738-01 | 100 chlorine dioxide tests |
| HI93738-03 | 300 chlorine dioxide tests |
| HI93739-01 | 100 fluoride HR tests |
| HI93739-03 | 300 fluoride HR tests |
| HI93740-01 | 50 nickel LR tests |
| HI93740-03 | 150 nickel LR tests |
| HI93746-01 | 50 iron LR tests |
| HI93746-03 | 150 iron LR tests |
| HI93748-01 | 50 manganese LR tests |
| HI93748-03 | 150 manganese LR tests |
| HI93749-01 | 100 chromium (VI) LR tests |
| HI93749-03 | 300 chromium (VI) LR tests |
| HI93750-01 | 100 potassium tests |
| HI93750-03 | 300 potassium tests |
| HI93751-01 | 100 sulfate tests |
| HI93751-03 | 300 sulfate tests |
| HI937520-01 | 50 magnesium tests |
| HI937520-03 | 150 magnesium tests |
| HI937521-01 | 50 calcium fresh water tests |
| HI937521-03 | 150 calcium fresh water tests |
| HI93753-01 | 100 chloride tests |
| HI93753-03 | 300 chloride tests |
| HI93757-01 | 100 ozone tests |
| HI93757-03 | 300 ozone tests |
| HI95747-01 | 100 copper LR tests |
| HI95747-03 | 300 copper LR tests |
| HI95761-01 | 100 chlorine total ULR tests |
| HI95761-03 | 300 chlorine total ULR tests |
| HI95762-01 | 100 chlorine free ULR tests |
| HI95762-03 | 300 chlorine free ULR tests |
| HI95769-01 | 40 surfactants anionic tests |
| HI96770-01 | 100 silica HR tests |
| HI96770-03 | 300 silica HR tests |

| Code | Description |
|------------|------------------------------|
| HI95771-01 | 100 chlorine total UHR tests |
| HI95771-03 | 300 chlorine total UHR tests |
| HI96773-01 | 50 oxygen scavengers tests |
| HI96773-03 | 150 oxygen scavengers tests |

11.2 pH ELECTRODES

| Code | Description |
|---------|---|
| HI10530 | Triple ceramic, double junction, low temperature glass, refillable pH electrode with conical tip and temperature sensor |
| HI10430 | Triple ceramic, double junction, high temperature glass, refillable pH electrode with temperature sensor |
| HI11310 | Glass body, double junction, refillable pH/temperature electrode |
| HI11311 | Glass body, double junction, refillable pH/temperature electrode with enhanced diagnostics |
| HI12300 | Plastic body, double junction, gel filled, non refillable pH/temperature electrode |
| HI12301 | Plastic body, double junction, gel filled, non refillable pH/temperature electrode with enhanced diagnostics |
| HI10480 | Glass body, double junction with temperature sensor for wine analysis |
| FC2320 | Double junction, open reference, non refillable, electrolyte viscolene, PVDF body with conical tip, pH/temperature electrode |
| FC2100 | Double junction, open reference, non refillable, electrolyte viscolene, glass body with conical tip, pH/temperature electrode |
| FC2020 | Double junction, open reference, non refillable, electrolyte viscolene, PVDF body with conical tip, pH/temperature electrode |

Note: The enhanced diagnostics information are not displayed by meter.

11.3 pH SOLUTIONS

BUFFER SOLUTIONS

| Code | Description |
|----------|---|
| HI70004P | pH 4.01 Buffer Sachets, 20 mL (25 pcs.) |
| HI70007P | pH 7.01 Buffer Sachets, 20 mL (25 pcs.) |
| HI70010P | pH 10.01 Buffer Sachets, 20 mL (25 pcs.) |
| HI7001L | pH 1.68 Buffer Solution, 500 mL |
| HI7004L | pH 4.01 Buffer Solution, 500 mL |
| HI7006L | pH 6.86 Buffer Solution, 500 mL |
| HI7007L | pH 7.01 Buffer Solution, 500 mL |
| HI7009L | pH 9.18 Buffer Solution, 500 mL |
| HI7010L | pH 10.01 Buffer Solution, 500 mL |
| HI8004L | pH 4.01 Buffer Solution in FDA approved bottle, 500 mL |
| HI8006L | pH 6.86 Buffer Solution in FDA approved bottle, 500 mL |
| HI8007L | pH 7.01 Buffer Solution in FDA approved bottle, 500 mL |
| HI8009L | pH 9.18 Buffer Solution in FDA approved bottle, 500 mL |
| HI8010L | pH 10.01 Buffer Solution in FDA approved bottle, 500 mL |

ELECTRODE STORAGE SOLUTIONS

| | |
|----------|---|
| HI70300L | Storage Solution, 500 mL |
| HI80300L | Storage Solution in FDA approved bottle, 500 mL |

ELECTRODE CLEANING SOLUTIONS

| | |
|----------|--|
| HI70000P | Electrode Rinse Sachets, 20 mL (25 pcs.) |
| HI7061L | General Cleaning Solution, 500 mL |
| HI7073L | Protein Cleaning Solution, 500 mL |
| HI7074L | Inorganic Cleaning Solution, 500 mL |
| HI7077L | Oil & Fat Cleaning Solution, 500 mL |
| HI8061L | General Cleaning Solution in FDA approved bottle, 500 mL |
| HI8073L | Protein Cleaning Solution in FDA approved bottle, 500 mL |
| HI8077L | Oil & Fat Cleaning Solution in FDA approved bottle, 500 mL |

ELECTRODE REFILL ELECTROLYTE SOLUTIONS

| | |
|---------|---|
| HI 7082 | 3.5M KCl Electrolyte, 4x30 mL, for double junction electrodes |
| HI 8082 | 3.5M KCl Electrolyte in FDA approved bottle, 4x30 mL, for double junction electrodes. |

11.4. OTHER ACCESSORIES

| Code | Description |
|--------------|---|
| HI72083300 | carrying case |
| HI731318 | cloth for wiping cuvettes (4 pcs.) |
| HI731331 | glass cuvettes (4 pcs.) |
| HI731335N | cap for cuvette (4 pcs.) |
| HI731340 | 200 μ L automatic pipette |
| HI731341 | 1000 μ L automatic pipette |
| HI731342 | 2000 μ L automatic pipette |
| HI740034P | cap for 100 mL beaker (10 pcs.) |
| HI740036P | 100 mL plastic beaker (10 pcs.) |
| HI740038 | 60 mL glass bottle and stopper |
| HI740142P | 1 mL graduated syringe (10 pcs) |
| HI740143 | 1 mL graduated syringe (6 pcs.) |
| HI740144 | pipette tip (6 pcs.) |
| HI740157P | plastic refilling pipette (20 pcs.) |
| HI740220 | 25 mL graduated glass vial (2 pcs.) |
| HI740223 | 170 mL plastic beaker |
| HI740224 | 170 mL plastic beaker (12 pcs.) |
| HI740225 | 60 mL graduated syringe |
| HI740226 | 5 mL graduated syringe |
| HI740227 | filter assembly |
| HI740228 | filter discs (25 pcs.) |
| HI 740229 | 100 mL graduated cylinder |
| DEMI-02 | demineralizer |
| HI75110/220E | USB power adapter, European plug |
| HI75110/220U | USB power adapter, USA plug |
| HI76404A | electrode holder |
| HI83300-11 | CAL Check cuvette kit for HI83300 |
| HI83300-100 | Sample preparation kit consisting of activated carbon for 50 tests, demineralizer bottle for 10 L of water, 100 mL graduated beaker with cap, 170 mL graduated beaker with cap, 3 mL pipette, 60 mL syringe, 5 mL syringe, graduated cylinder, spoon, funnel, filter paper (25 pcs.). |
| HI920015 | USB to micro USB cable connector |
| HI93703-50 | cuvette cleaning solution (230 mL) |
| HI93703-55 | activated carbon (50 pcs.) |

12. ABBREVIATIONS

| | |
|-------|--------------------------------------|
| EPA: | US Environmental Protection Agency |
| °C: | degree Celsius |
| °F: | degree Fahrenheit |
| μg/L: | micrograms per liter (ppb) |
| mg/L: | milligrams per liter (ppm) |
| g/L: | grams per liter (ppt) |
| mL: | milliliter |
| GLP | good laboratory practice |
| UHR | ultra high range |
| ULR | ultra low range |
| HR: | high range |
| MR: | medium range |
| LR: | low range |
| PAN: | 1-(2-pyridylazo)-2-naphthol |
| TPTZ: | 2,4,6-tri-(2-pyridyl)-1,3,5-triazine |

Recommendations for Users

Before using this product make sure that they are entirely suitable for your specific application and for the environment in which they are used.

Operation of these instruments may cause unacceptable interferences to other electronic equipment. Take all necessary steps to correct such interferences. Any variation introduced by the user to the supplied equipment may degrade the instruments EMC performance.

To avoid damages or burns, do not put the instrument in a microwave oven. For yours and the instrument safety do not use or store the instrument in hazardous environments.

Warranty

The HI83300 is warranted for two years against defects in workmanship and materials when used for their intended purpose and maintained according to instructions. Damage due to accidents, misuse, tampering or lack of prescribed maintenance is not covered.

If service is required, contact your local Hanna Instruments Office. If under warranty, report the model number, date of purchase, serial number and the nature of the problem. If the repair is not covered by the warranty, you will be notified of the charges incurred. If the instrument is to be returned to Hanna Instruments, first obtain a Returned Goods Authorization (RGA) number from the Technical Service department and then send it with shipping costs prepaid. When shipping any instrument, make sure it is properly packed for complete protection.

Hanna Instruments reserves the right to modify the design, construction or appearance of its products without advance notice.

World Headquarters

Hanna Instruments Inc.
Highland Industrial Park
584 Park East Drive
Woonsocket, RI 02895 USA
www.hannainst.com

Local Office

Hanna Instruments USA
270 George Washington Highway
Smithfield, RI 02917
Phone: 800.426.6287
Fax: 401.765.7575
e-mail: tech@hannainst.com



MAN83300

Printed in ROMANIA